

MET: $\chi_3(\phi, \psi|r=\langle g^+, g^+, g^+ \rangle)$, 0.39%

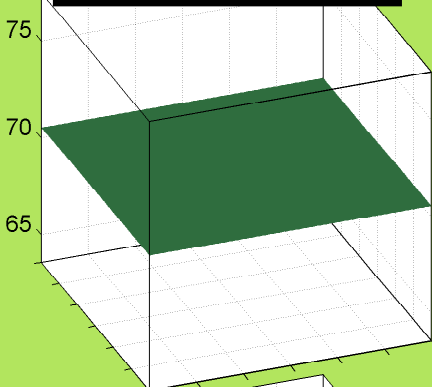

MET: $\chi_3(\phi, \psi|r=\langle g^+, g^+, t \rangle)$, 0.18%

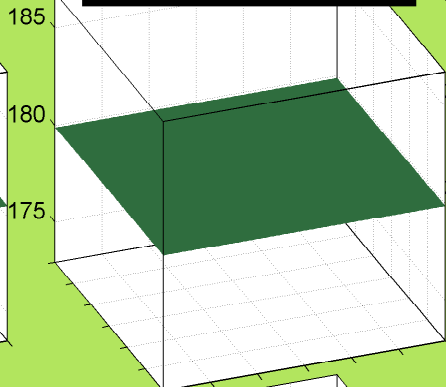

MET: $\chi_3(\phi, \psi|r=\langle g^+, g^+, g^- \rangle)$, 0.01%

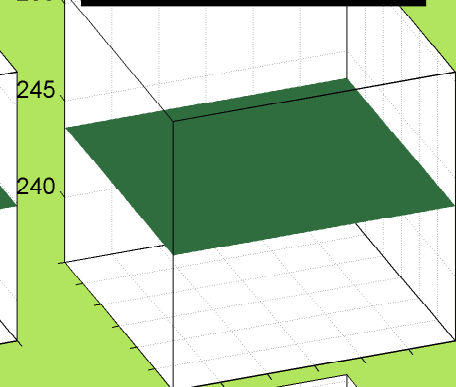

MET: $\chi_3(\phi, \psi|r=\langle g^+, t, g^+ \rangle)$, 2.21%

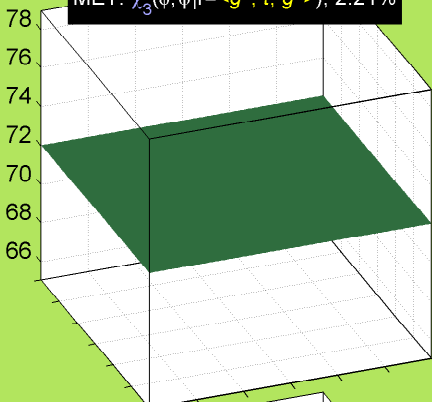

MET: $\chi_3(\phi, \psi|r=\langle g^+, t, t \rangle)$, 1.50%

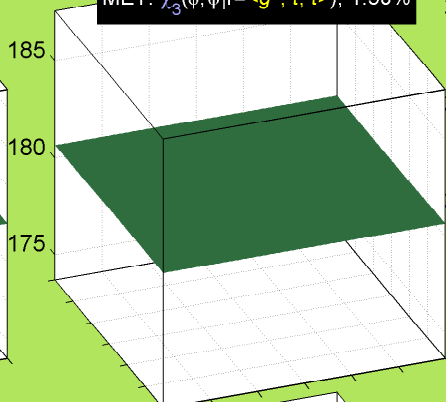

MET: $\chi_3(\phi, \psi|r=\langle g^+, t, g^- \rangle)$, 2.34%

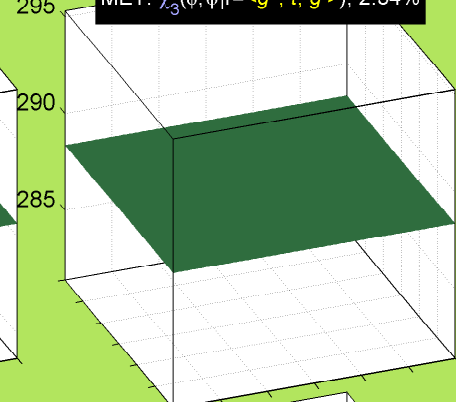

MET: $\chi_3(\phi, \psi|r=\langle g^+, g^-, g^+ \rangle)$, 0.01%

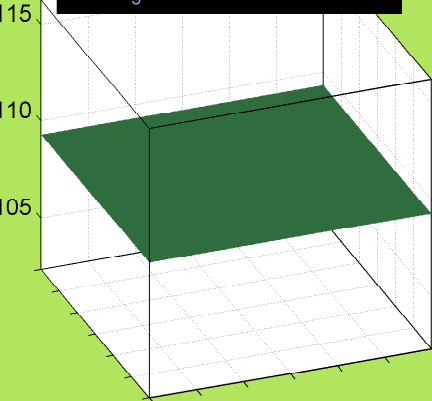

MET: $\chi_3(\phi, \psi|r=\langle g^+, g^-, t \rangle)$, 0.11%

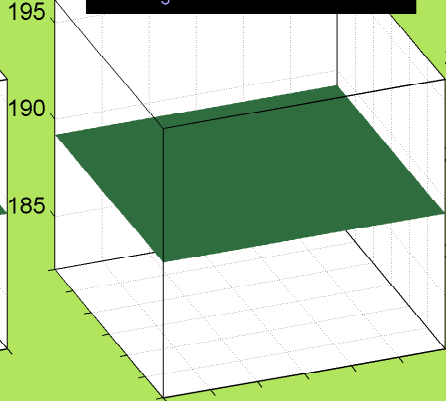

MET: $\chi_3(\phi, \psi|r=\langle g^+, g^-, g^- \rangle)$, 0.25%

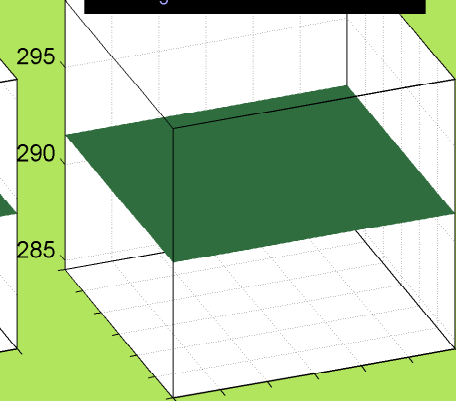

MET: $\gamma_3(\phi, \psi|r=\langle t, g^+, g^+ \rangle)$, 6.70%

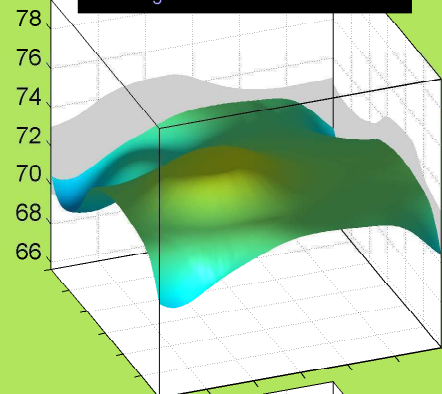

MET: $\gamma_3(\phi, \psi|r=\langle t, g^+, t \rangle)$, 1.79%

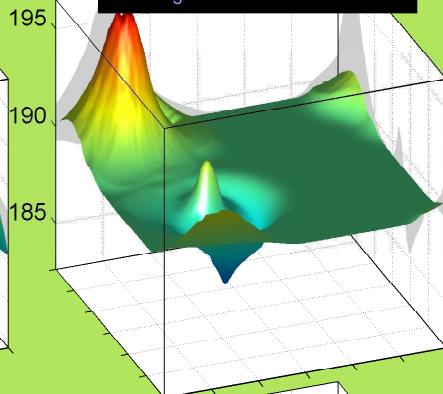

MET: $\gamma_3(\phi, \psi|r=\langle t, g^+, g^- \rangle)$, 0.48%

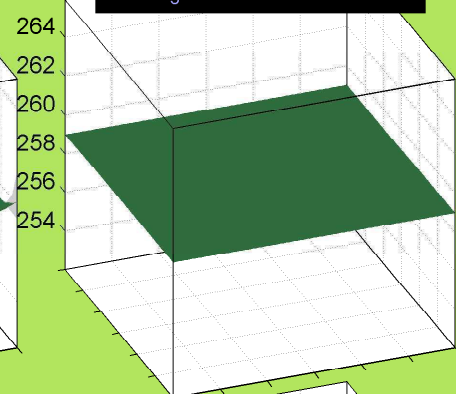

MET: $\gamma_3(\phi, \psi|r=\langle t, t, g^+ \rangle)$, 7.37%

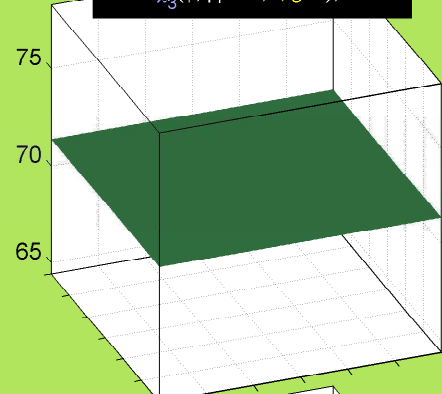

MET: $\gamma_3(\phi, \psi|r=\langle t, t, t \rangle)$, 3.51%

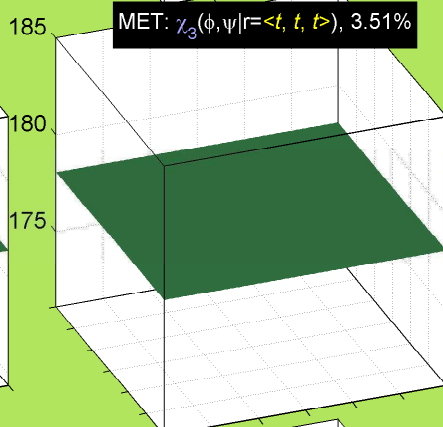

MET: $\gamma_3(\phi, \psi|r=\langle t, t, g^- \rangle)$, 7.17%

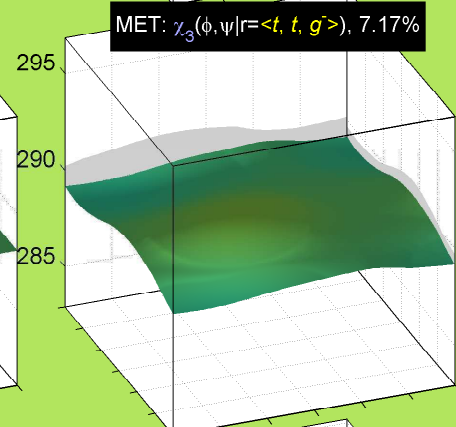

MET: $\gamma_3(\phi, \psi|r=\langle t, g^-, g^+ \rangle)$, 0.02%

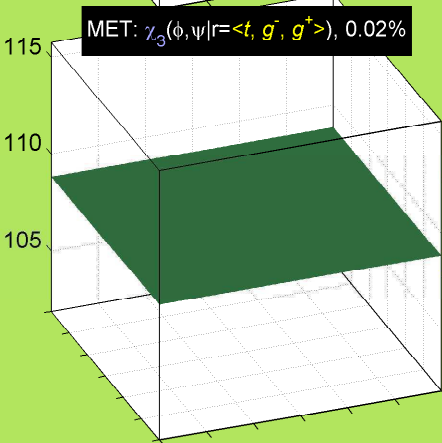

MET: $\gamma_3(\phi, \psi|r=\langle t, g^-, t \rangle)$, 0.24%

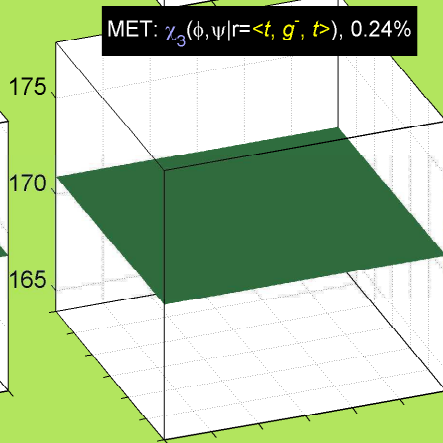

MET: $\gamma_3(\phi, \psi|r=\langle t, g^-, g^- \rangle)$, 1.78%

