

LYS: $\sigma_{\gamma_4}(\phi, \psi | r = \langle g^+, g^+, g^+, g^+ \rangle)$, 0.01%

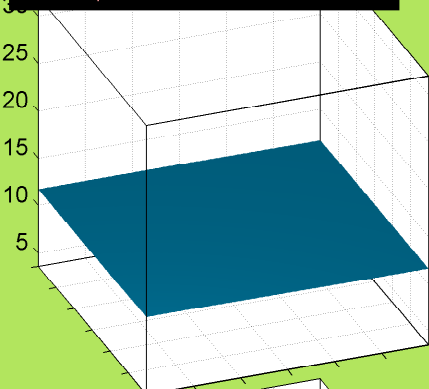

LYS: $\sigma_{\gamma_4}(\phi, \psi | r = \langle g^+, g^+, g^+, t \rangle)$, 0.01%

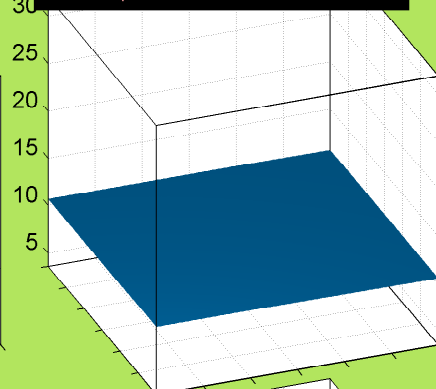

LYS: $\sigma_{\gamma_4}(\phi, \psi | r = \langle g^+, g^+, g^+, g^- \rangle)$, 0.01%

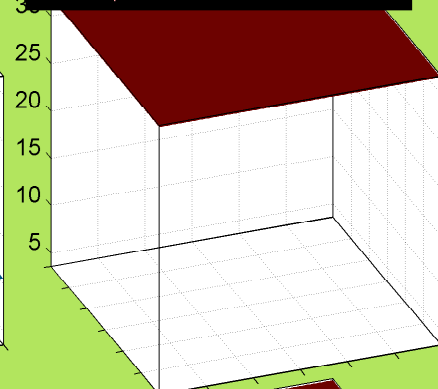

LYS: $\sigma_{\gamma_4}(\phi, \psi | r = \langle g^+, g^+, t, g^+ \rangle)$, 0.03%

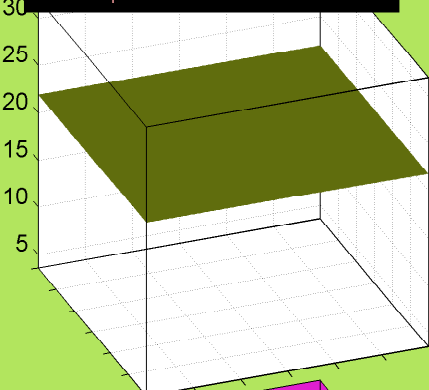

LYS: $\sigma_{\gamma_4}(\phi, \psi | r = \langle g^+, g^+, t, t \rangle)$, 0.08%

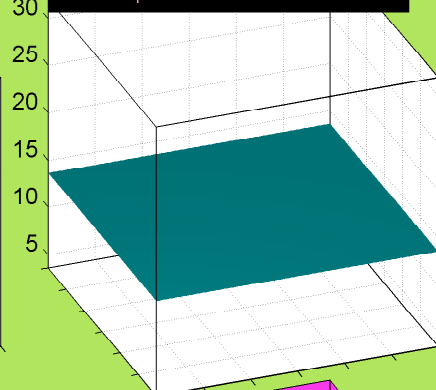

LYS: $\sigma_{\gamma_4}(\phi, \psi | r = \langle g^+, g^+, t, g^- \rangle)$, 0.01%

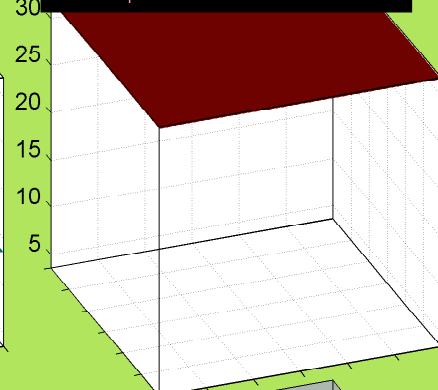

LYS: $\sigma_{\gamma_4}(\phi, \psi | r = \langle g^+, g^+, g^-, g^+ \rangle)$, 0.00%

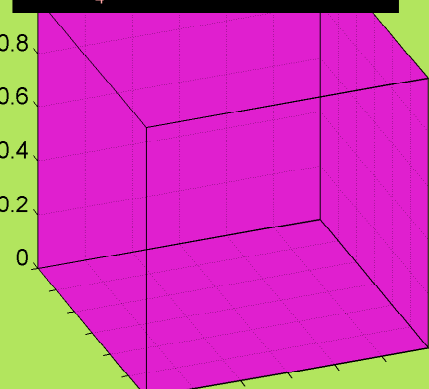

LYS: $\sigma_{\gamma_4}(\phi, \psi | r = \langle g^+, g^+, g^-, t \rangle)$, 0.00%

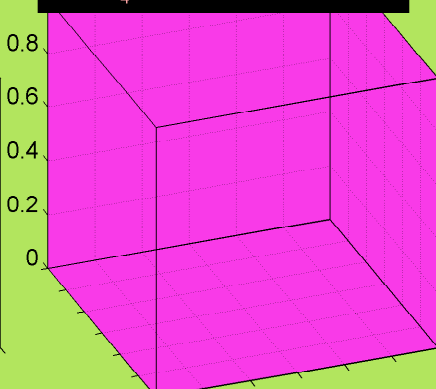

LYS: $\sigma_{\gamma_4}(\phi, \psi | r = \langle g^+, g^+, g^-, g^- \rangle)$, 0.00%

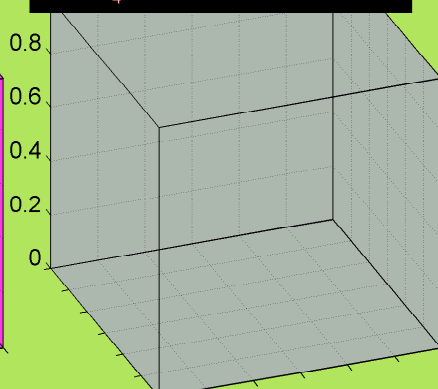

LYS: $\sigma_{\chi_4}(\phi, \psi | r = \langle g^+, t, g^+, g^+ \rangle)$, 0.26%

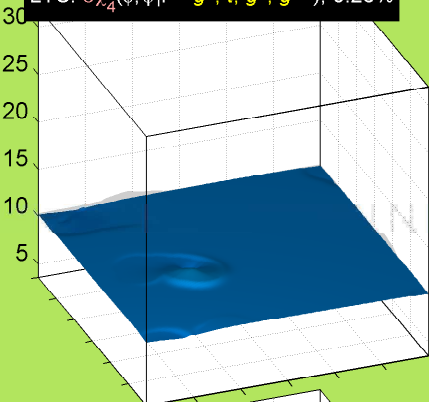

LYS: $\sigma_{\chi_4}(\phi, \psi | r = \langle g^+, t, g^+, t \rangle)$, 0.48%

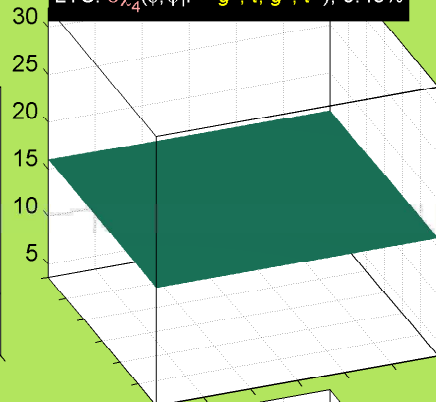

LYS: $\sigma_{\chi_4}(\phi, \psi | r = \langle g^+, t, g^+, g^- \rangle)$, 0.04%

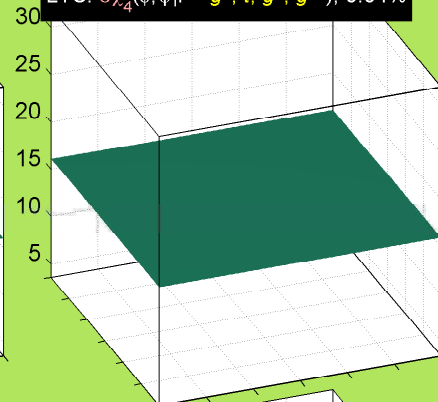

LYS: $\sigma_{\chi_4}(\phi, \psi | r = \langle g^+, t, t, g^+ \rangle)$, 0.78%

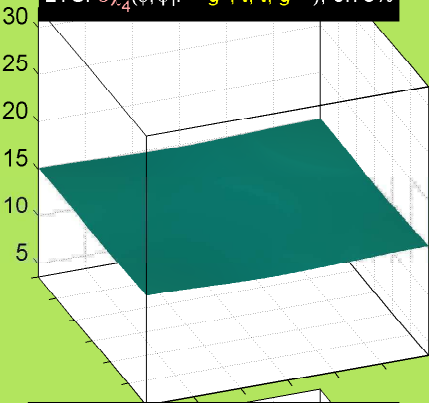

LYS: $\sigma_{\chi_4}(\phi, \psi | r = \langle g^+, t, t, t \rangle)$, 3.39%

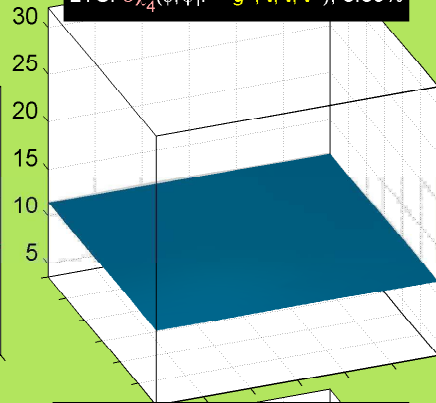

LYS: $\sigma_{\chi_4}(\phi, \psi | r = \langle g^+, t, t, g^- \rangle)$, 0.79%

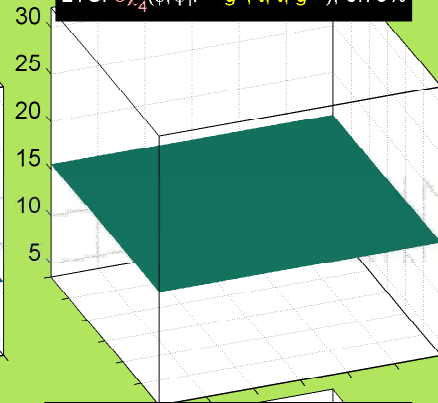

LYS: $\sigma_{\chi_4}(\phi, \psi | r = \langle g^+, t, g^-, g^+ \rangle)$, 0.02%

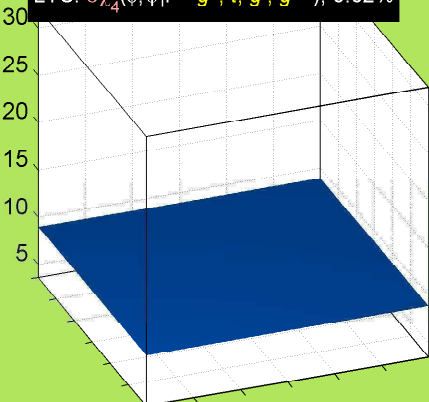

LYS: $\sigma_{\chi_4}(\phi, \psi | r = \langle g^+, t, g^-, t \rangle)$, 0.62%

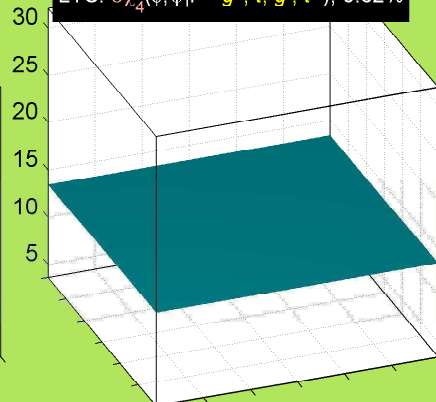

LYS: $\sigma_{\chi_4}(\phi, \psi | r = \langle g^+, t, g^-, g^- \rangle)$, 0.23%

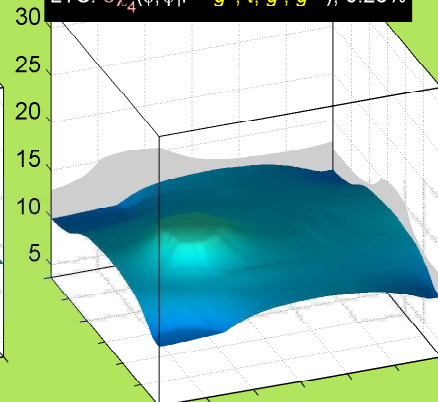

LYS: $\sigma_{\chi_4}(\phi, \psi | r = \langle g^+, g^-, g^+, g^+ \rangle)$, 0.00%

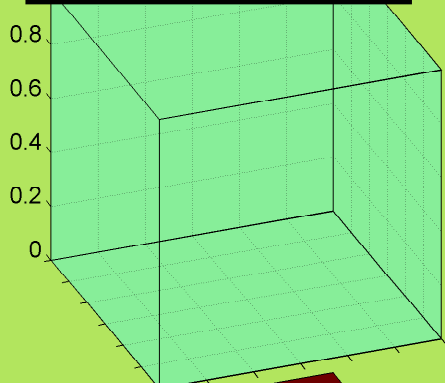

1 LYS: $\sigma_{\chi_4}(\phi, \psi | r = \langle g^+, g^-, g^+, t \rangle)$, 0.00%

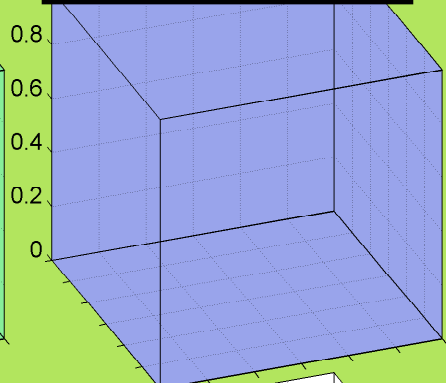

LYS: $\sigma_{\chi_4}(\phi, \psi | r = \langle g^+, g^-, g^+, g^- \rangle)$, 0.00%

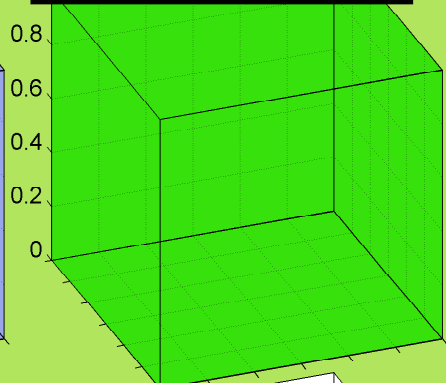

LYS: $\sigma_{\chi_4}(\phi, \psi | r = \langle g^+, g^-, t, g^+ \rangle)$, 0.01%

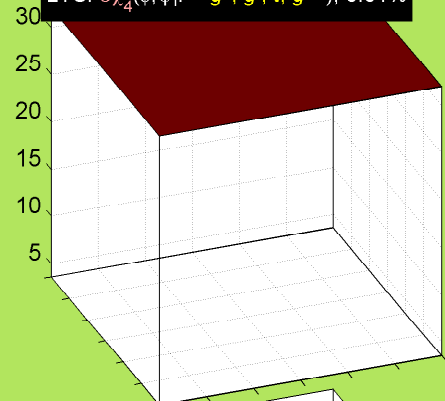

LYS: $\sigma_{\chi_4}(\phi, \psi | r = \langle g^+, g^-, t, t \rangle)$, 0.04%

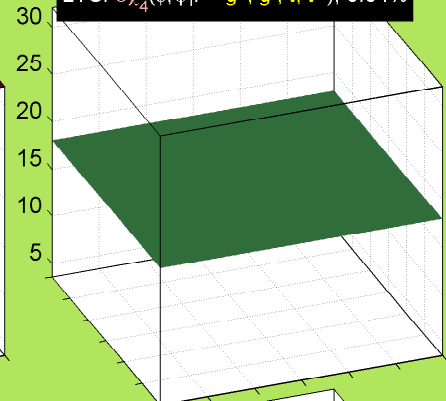

LYS: $\sigma_{\chi_4}(\phi, \psi | r = \langle g^+, g^-, t, g^- \rangle)$, 0.02%

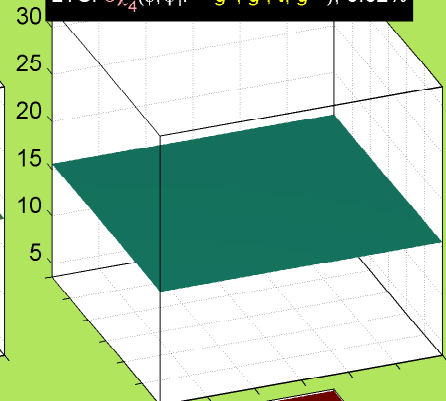

LYS: $\sigma_{\chi_4}(\phi, \psi | r = \langle g^+, g^-, g^-, g^+ \rangle)$, 0.01%

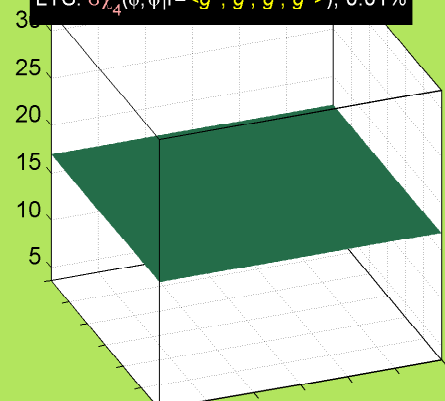

LYS: $\sigma_{\chi_4}(\phi, \psi | r = \langle g^+, g^-, g^-, t \rangle)$, 0.02%

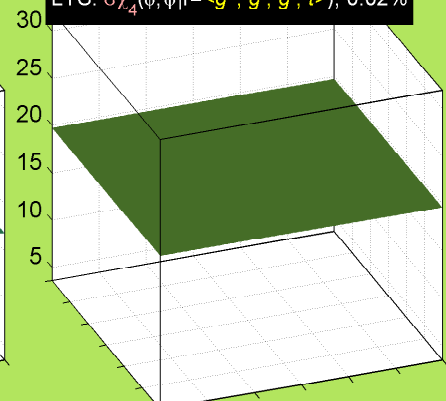

LYS: $\sigma_{\chi_4}(\phi, \psi | r = \langle g^+, g^-, g^-, g^- \rangle)$, 0.00%

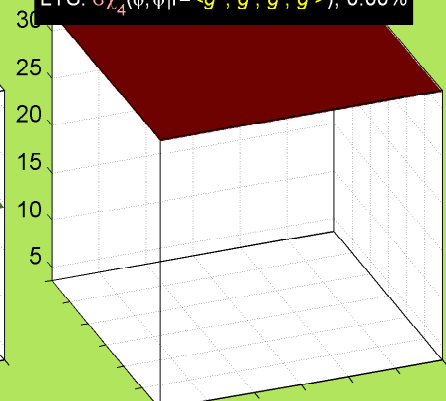

LYS: $\sigma_{\gamma_4}(\phi, \psi | r = \langle t, g^+, g^+, g^+ \rangle)$, 0.14%

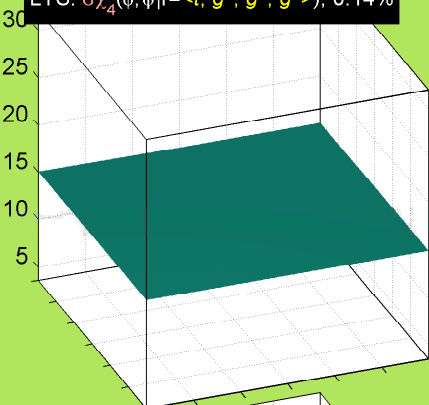

LYS: $\sigma_{\gamma_4}(\phi, \psi | r = \langle t, g^+, g^+, t \rangle)$, 0.63%

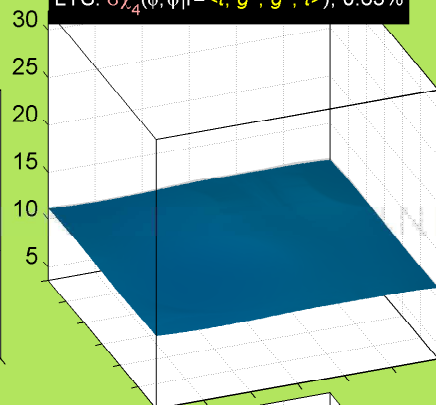

LYS: $\sigma_{\gamma_4}(\phi, \psi | r = \langle t, g^+, g^+, g^- \rangle)$, 0.04%

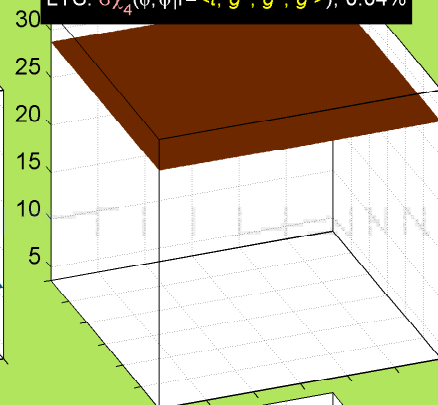

LYS: $\sigma_{\gamma_4}(\phi, \psi | r = \langle t, g^+, t, g^+ \rangle)$, 1.09%

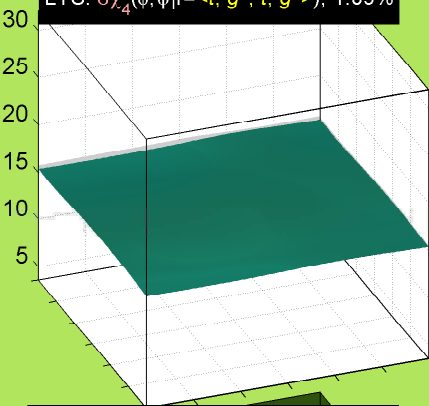

LYS: $\sigma_{\gamma_4}(\phi, \psi | r = \langle t, g^+, t, t \rangle)$, 2.96%

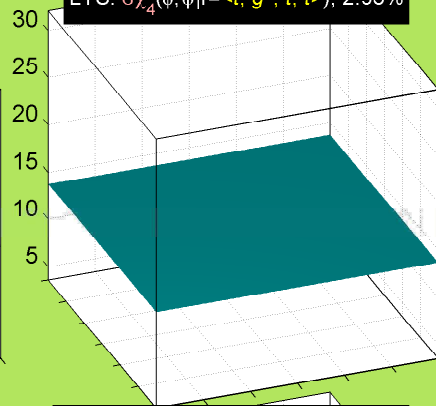

LYS: $\sigma_{\gamma_4}(\phi, \psi | r = \langle t, g^+, t, g^- \rangle)$, 0.78%

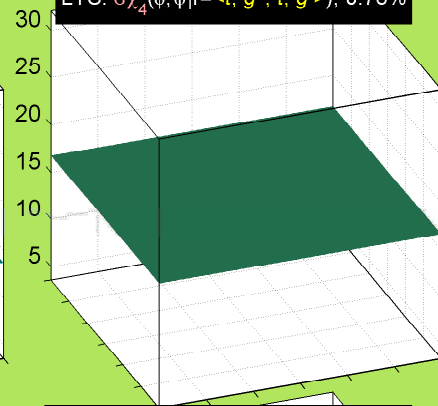

LYS: $\sigma_{\gamma_4}(\phi, \psi | r = \langle t, g^+, g^-, g^+ \rangle)$, 0.00%

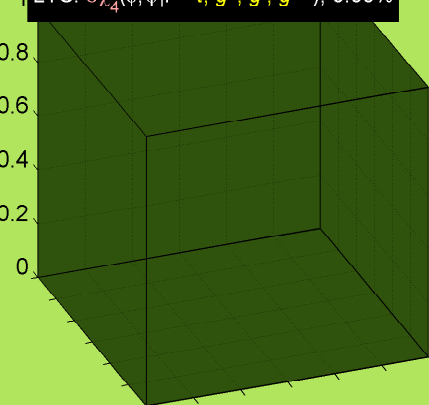

LYS: $\sigma_{\gamma_4}(\phi, \psi | r = \langle t, g^+, g^-, t \rangle)$, 0.08%

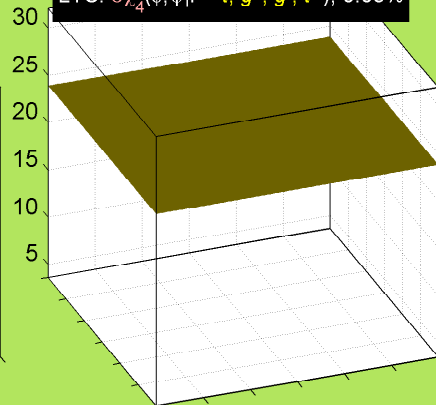

LYS: $\sigma_{\gamma_4}(\phi, \psi | r = \langle t, g^+, g^-, g^- \rangle)$, 0.02%

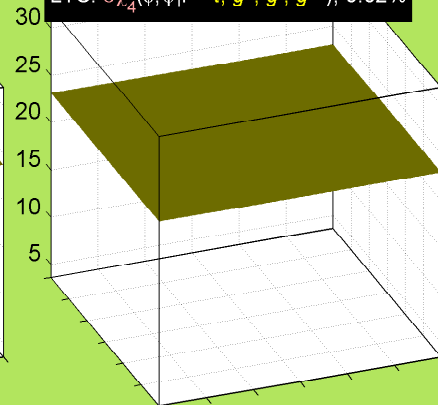

LYS: $\sigma_{\chi_4}(\phi, \psi | r = \langle t, t, g^+, g^+ \rangle)$, 0.77%

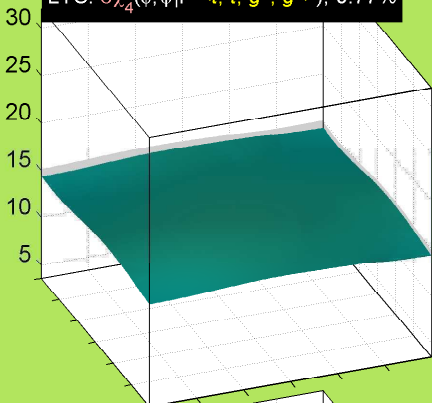

LYS: $\sigma_{\chi_4}(\phi, \psi | r = \langle t, t, g^+, t \rangle)$, 2.64%

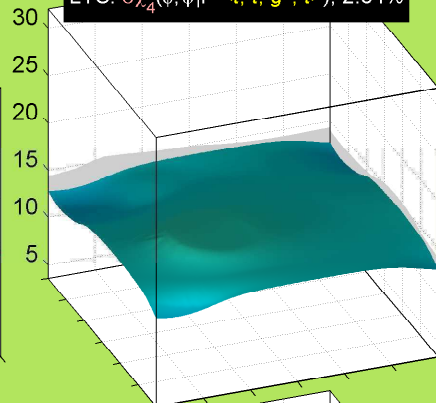

LYS: $\sigma_{\chi_4}(\phi, \psi | r = \langle t, t, g^+, g^- \rangle)$, 0.17%

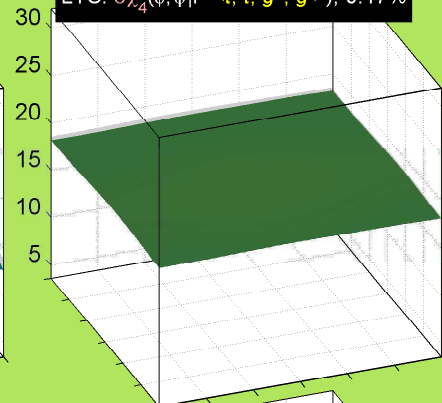

LYS: $\sigma_{\chi_4}(\phi, \psi | r = \langle t, t, t, g^+ \rangle)$, 4.06%

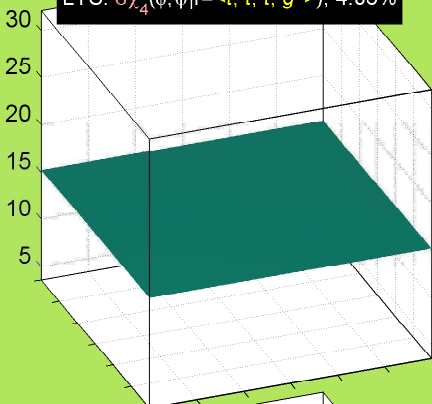

LYS: $\sigma_{\chi_4}(\phi, \psi | r = \langle t, t, t, t \rangle)$, 13.46%

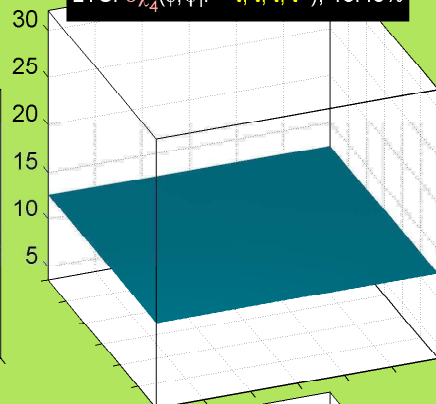

LYS: $\sigma_{\chi_4}(\phi, \psi | r = \langle t, t, t, g^- \rangle)$, 3.70%

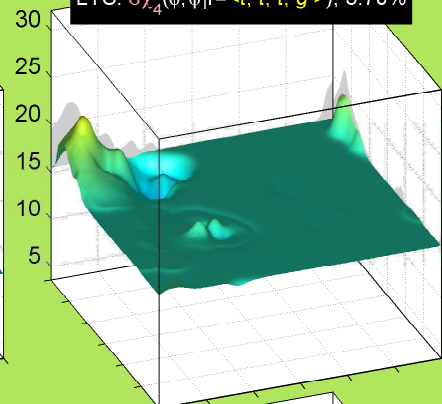

LYS: $\sigma_{\chi_4}(\phi, \psi | r = \langle t, t, g^-, g^+ \rangle)$, 0.13%

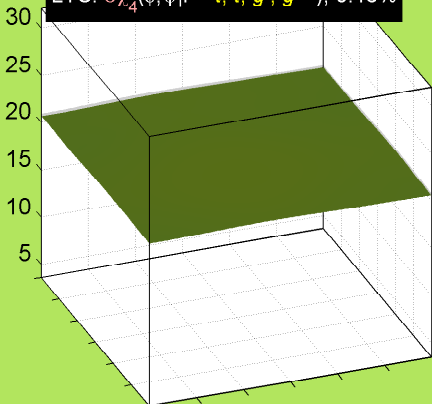

LYS: $\sigma_{\chi_4}(\phi, \psi | r = \langle t, t, g^-, t \rangle)$, 2.42%

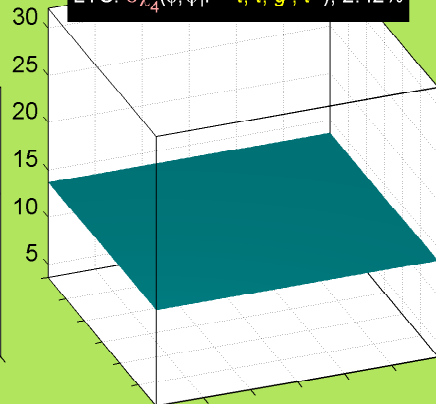

LYS: $\sigma_{\chi_4}(\phi, \psi | r = \langle t, t, g^-, g^- \rangle)$, 0.69%

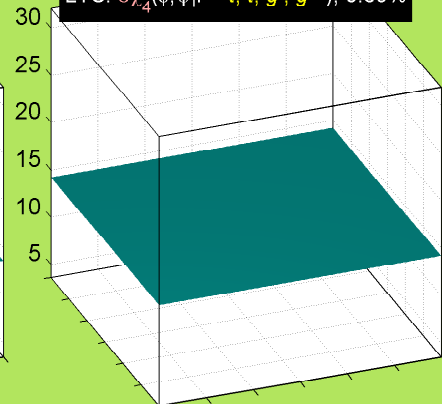

LYS: $\sigma_{\chi_4}(\phi, \psi | r = \langle t, g^-, g^+, g^+ \rangle)$, 0.01%

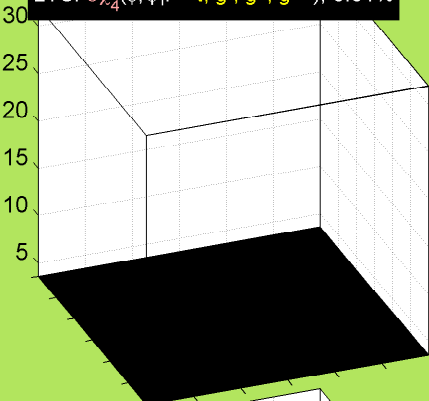

LYS: $\sigma_{\chi_4}(\phi, \psi | r = \langle t, g^-, g^+, t \rangle)$, 0.00%

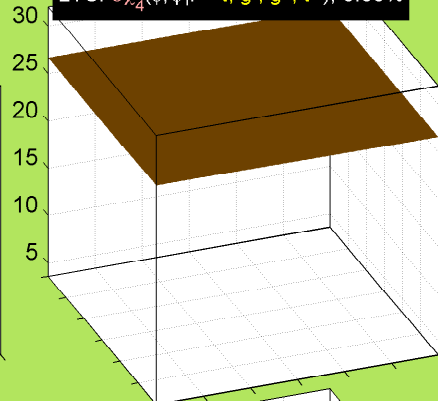

LYS: $\sigma_{\chi_4}(\phi, \psi | r = \langle t, g^-, g^+, g^- \rangle)$, 0.00%

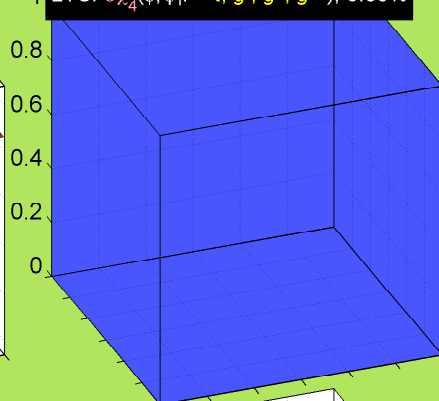

LYS: $\sigma_{\chi_4}(\phi, \psi | r = \langle t, g^-, t, g^+ \rangle)$, 0.06%

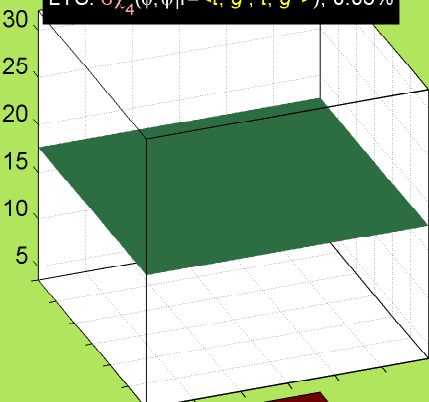

LYS: $\sigma_{\chi_4}(\phi, \psi | r = \langle t, g^-, t, t \rangle)$, 0.28%

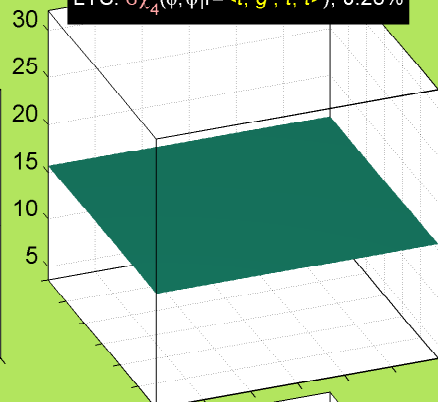

LYS: $\sigma_{\chi_4}(\phi, \psi | r = \langle t, g^-, t, g^- \rangle)$, 0.10%

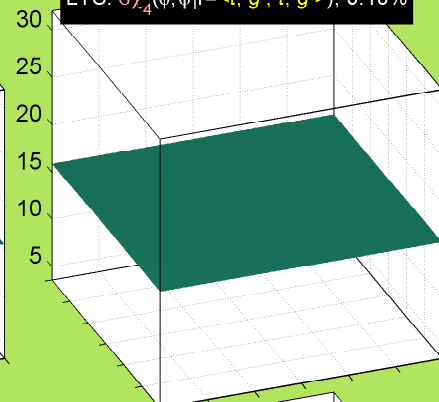

LYS: $\sigma_{\chi_4}(\phi, \psi | r = \langle t, g^-, g^-, g^+ \rangle)$, 0.00%

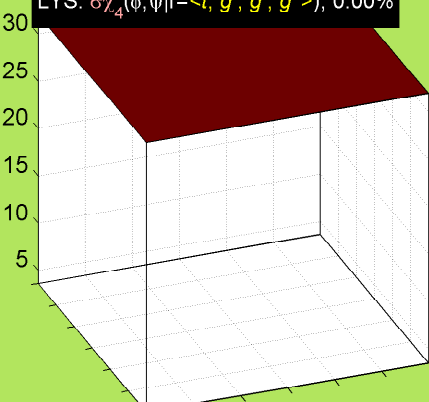

LYS: $\sigma_{\chi_4}(\phi, \psi | r = \langle t, g^-, g^-, t \rangle)$, 0.10%

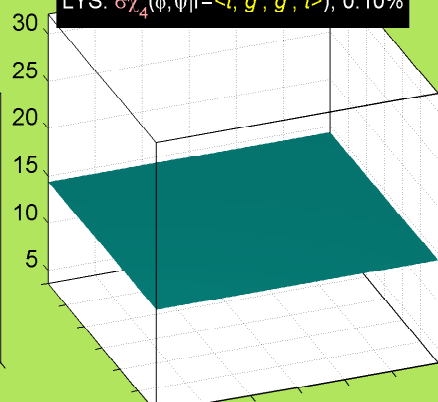

LYS: $\sigma_{\chi_4}(\phi, \psi | r = \langle t, g^-, g^-, g^- \rangle)$, 0.03%

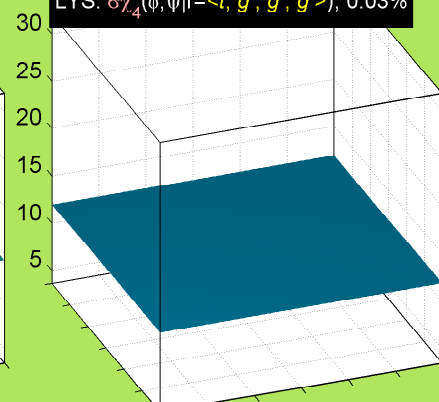

LYS: $\sigma_{\chi_4}(\phi, \psi | r = \langle g^-, g^+, g^+, g^+ \rangle)$, 0.02%

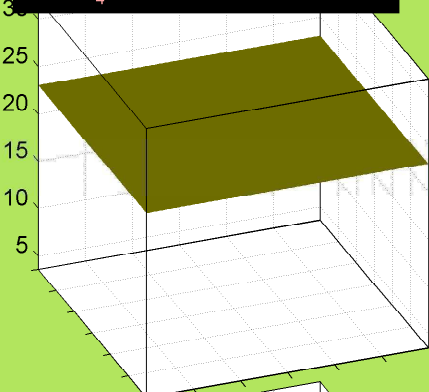

LYS: $\sigma_{\chi_4}(\phi, \psi | r = \langle g^-, g^+, g^+, t \rangle)$, 0.11%

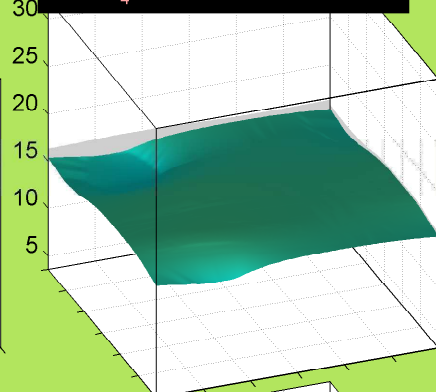

LYS: $\sigma_{\chi_4}(\phi, \psi | r = \langle g^-, g^+, g^+, g^- \rangle)$, 0.01%

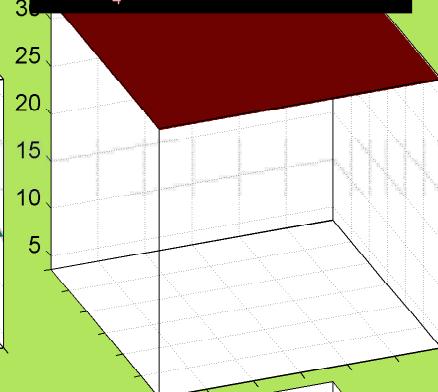

LYS: $\sigma_{\chi_4}(\phi, \psi | r = \langle g^-, g^+, t, g^+ \rangle)$, 0.14%

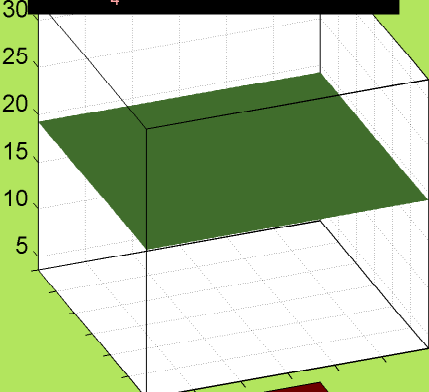

LYS: $\sigma_{\chi_4}(\phi, \psi | r = \langle g^-, g^+, t, t \rangle)$, 0.39%

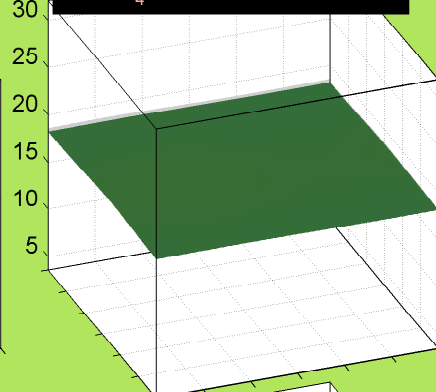

LYS: $\sigma_{\chi_4}(\phi, \psi | r = \langle g^-, g^+, t, g^- \rangle)$, 0.10%

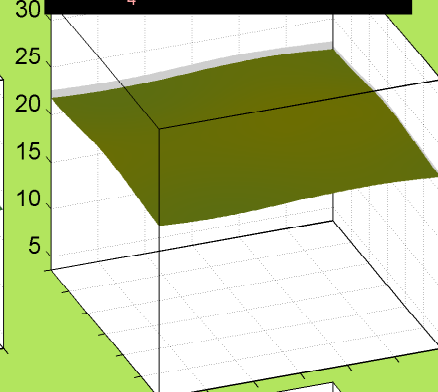

LYS: $\sigma_{\chi_4}(\phi, \psi | r = \langle g^-, g^+, g^-, g^+ \rangle)$, 0.01%

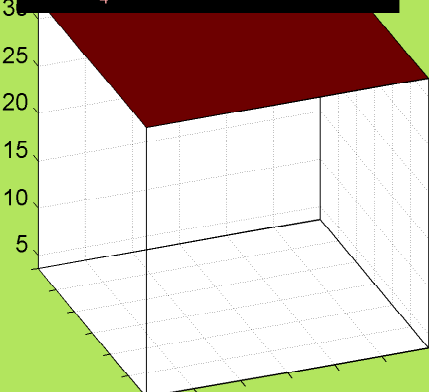

LYS: $\sigma_{\chi_4}(\phi, \psi | r = \langle g^-, g^+, g^-, t \rangle)$, 0.03%

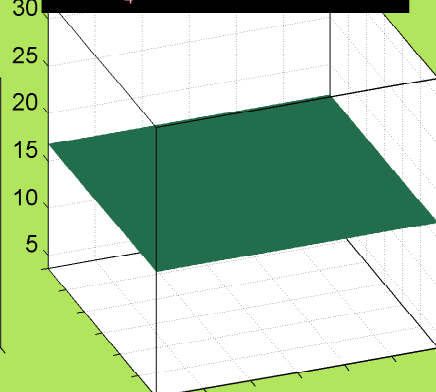

LYS: $\sigma_{\chi_4}(\phi, \psi | r = \langle g^-, g^+, g^-, g^- \rangle)$, 0.01%

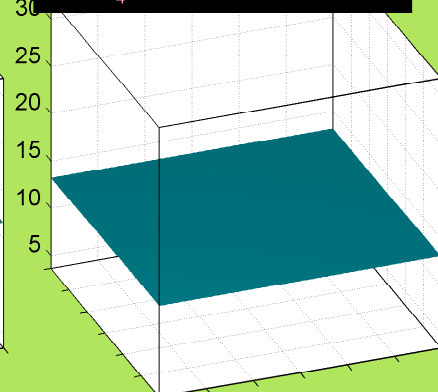

LYS: $\sigma_{\chi_4}(\phi, \psi | r = \langle g^-, t, g^+, g^+ \rangle)$, 1.29%

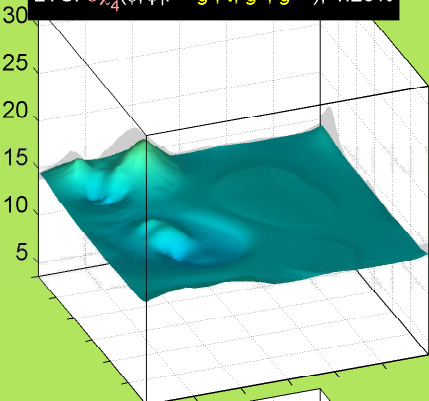

LYS: $\sigma_{\chi_4}(\phi, \psi | r = \langle g^-, t, g^+, t \rangle)$, 4.10%

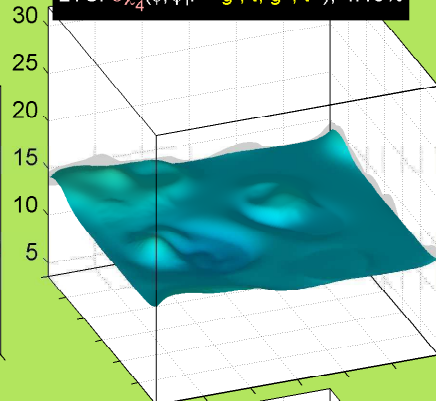

LYS: $\sigma_{\chi_4}(\phi, \psi | r = \langle g^-, t, g^+, g^- \rangle)$, 0.22%

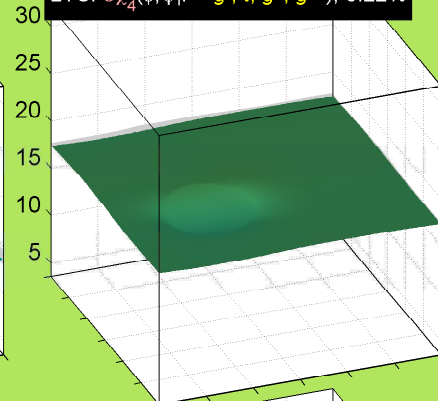

LYS: $\sigma_{\chi_4}(\phi, \psi | r = \langle g^-, t, t, g^+ \rangle)$, 4.77%

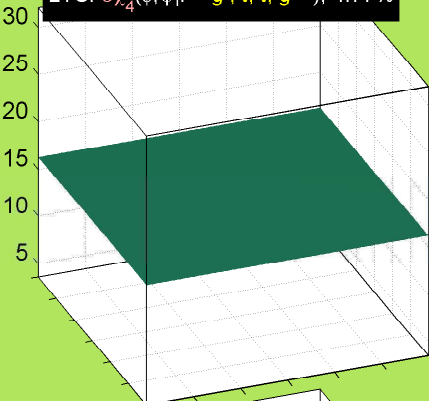

LYS: $\sigma_{\chi_4}(\phi, \psi | r = \langle g^-, t, t, t \rangle)$, 22.43%

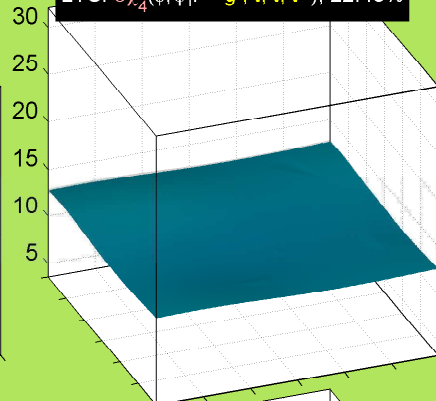

LYS: $\sigma_{\chi_4}(\phi, \psi | r = \langle g^-, t, t, g^- \rangle)$, 5.96%

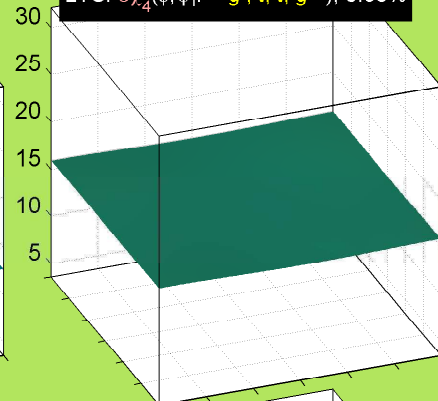

LYS: $\sigma_{\chi_4}(\phi, \psi | r = \langle g^-, t, g^-, g^+ \rangle)$, 0.20%

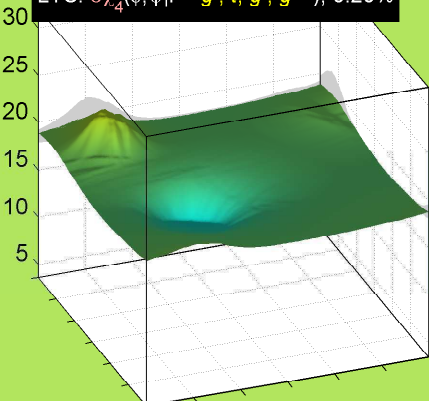

LYS: $\sigma_{\chi_4}(\phi, \psi | r = \langle g^-, t, g^-, t \rangle)$, 3.90%

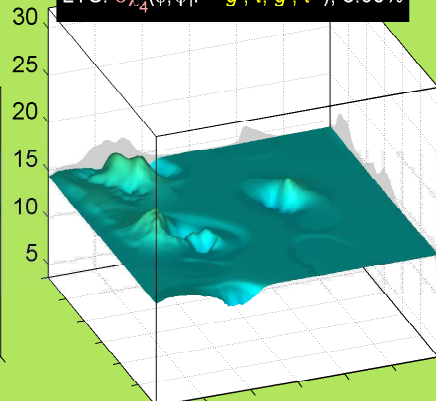

LYS: $\sigma_{\chi_4}(\phi, \psi | r = \langle g^-, t, g^-, g^- \rangle)$, 1.29%

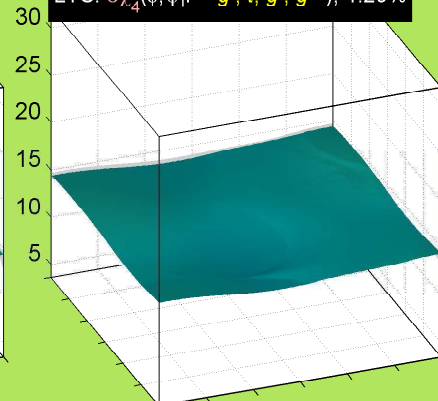

LYS: $\sigma\chi_4(\phi, \psi|r=\langle g^-, g^-, g^+, g^+ \rangle)$, 0.03%

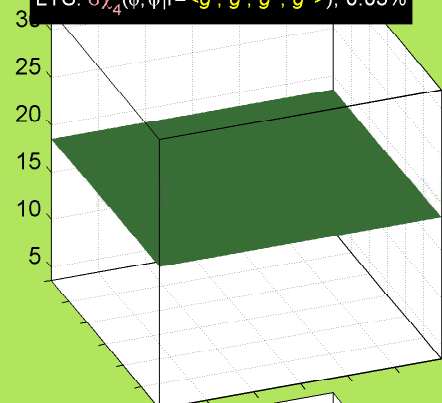

LYS: $\sigma\chi_4(\phi, \psi|r=\langle g^-, g^-, g^+, t \rangle)$, 0.19%

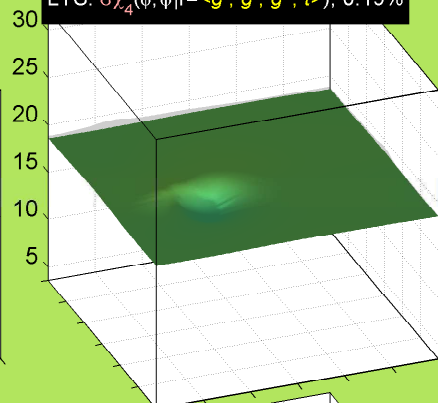

LYS: $\sigma\chi_4(\phi, \psi|r=\langle g^-, g^-, g^+, g^- \rangle)$, 0.01%

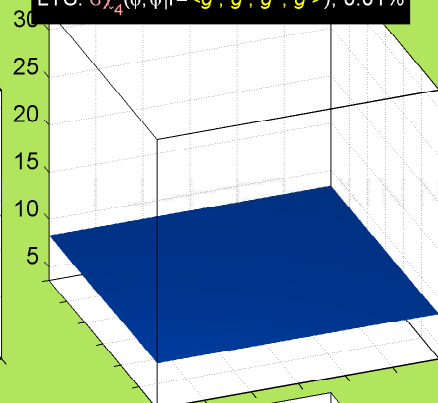

LYS: $\sigma\chi_4(\phi, \psi|r=\langle g^-, g^-, t, g^+ \rangle)$, 1.72%

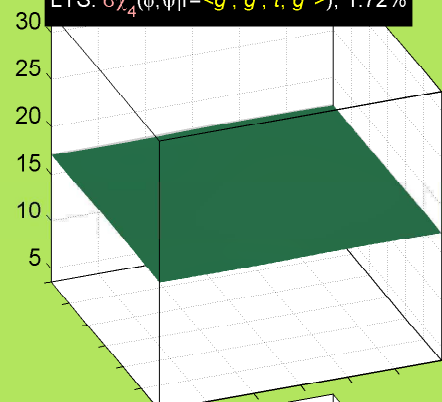

LYS: $\sigma\chi_4(\phi, \psi|r=\langle g^-, g^-, t, t \rangle)$, 7.64%

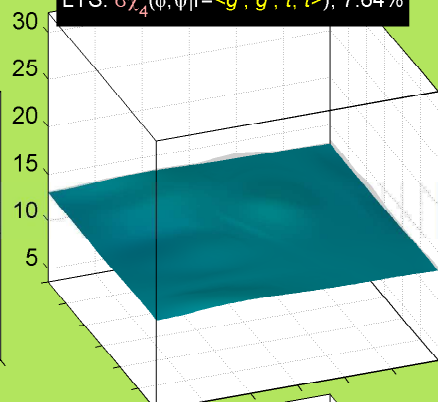

LYS: $\sigma\chi_4(\phi, \psi|r=\langle g^-, g^-, t, g^- \rangle)$, 2.24%

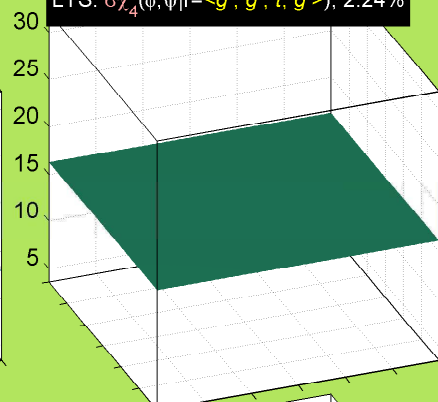

LYS: $\sigma\chi_4(\phi, \psi|r=\langle g^-, g^-, g^-, g^+ \rangle)$, 0.07%

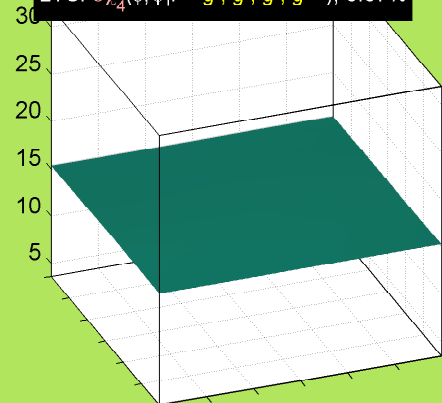

LYS: $\sigma\chi_4(\phi, \psi|r=\langle g^-, g^-, g^-, t \rangle)$, 1.60%

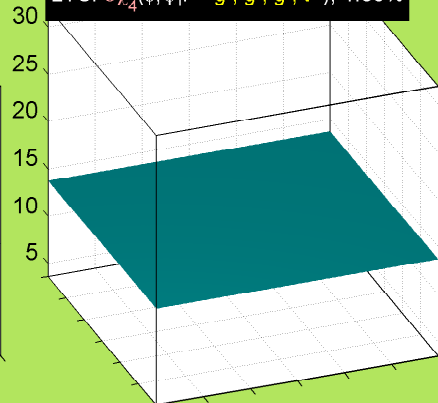

LYS: $\sigma\chi_4(\phi, \psi|r=\langle g^-, g^-, g^-, g^- \rangle)$, 0.30%

