

ARG:  $\gamma_4(\phi, \psi | r = \langle g^+, g^+, g^+, g^+ \rangle)$ , 0.03%

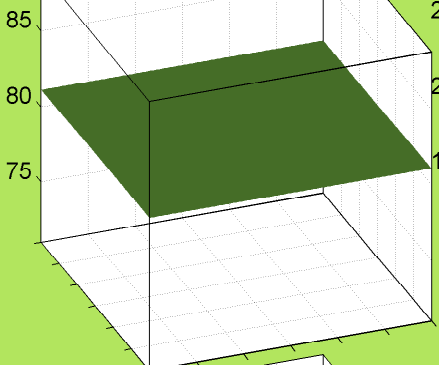

ARG:  $\gamma_4(\phi, \psi | r = \langle g^+, g^+, g^+, t \rangle)$ , 0.05%

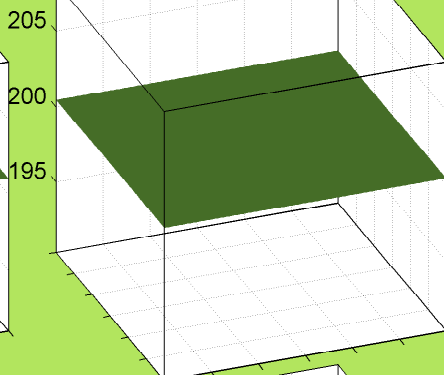

ARG:  $\gamma_4(\phi, \psi | r = \langle g^+, g^+, g^+, g^- \rangle)$ , 0.01%

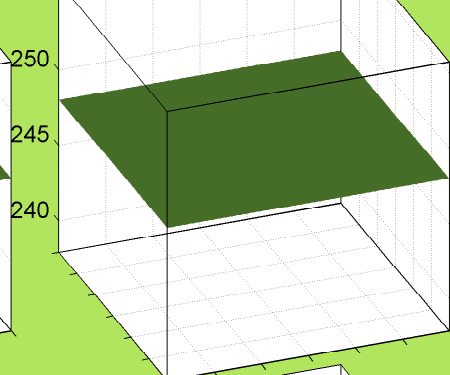

ARG:  $\gamma_4(\phi, \psi | r = \langle g^+, g^+, t, g^+ \rangle)$ , 0.06%

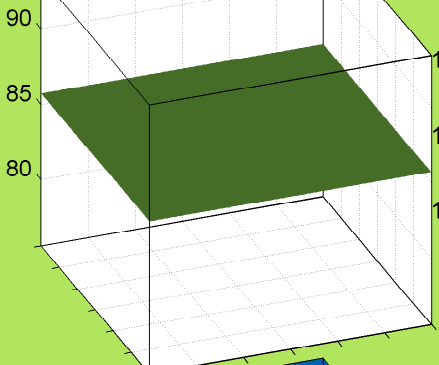

ARG:  $\gamma_4(\phi, \psi | r = \langle g^+, g^+, t, t \rangle)$ , 0.13%

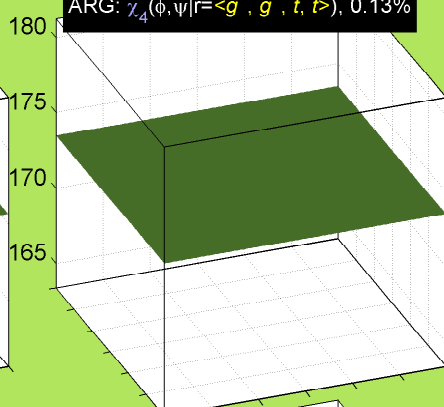

ARG:  $\gamma_4(\phi, \psi | r = \langle g^+, g^+, t, g^- \rangle)$ , 0.04%

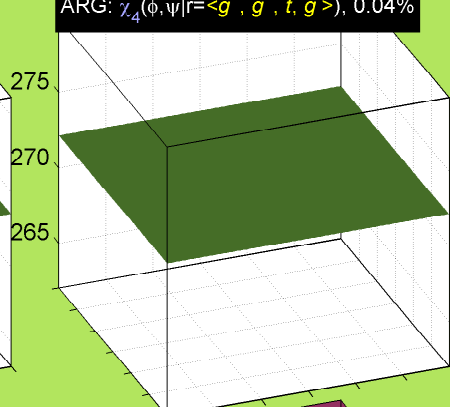

ARG:  $\gamma_4(\phi, \psi | r = \langle g^+, g^+, g^-, g^+ \rangle)$ , 0.00%

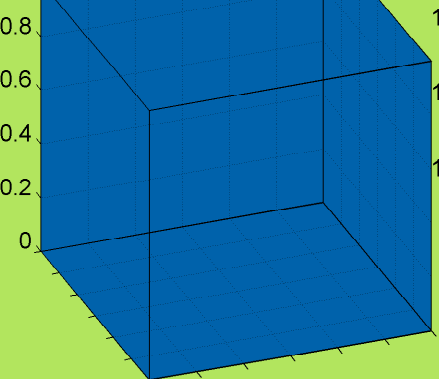

ARG:  $\gamma_4(\phi, \psi | r = \langle g^+, g^+, g^-, t \rangle)$ , 0.01%

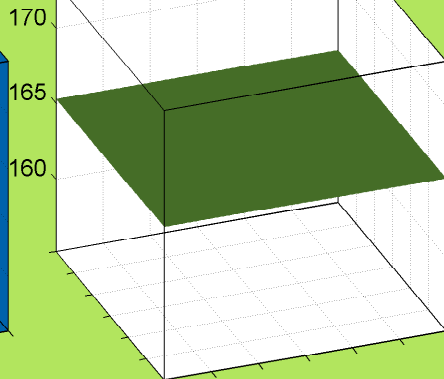

ARG:  $\gamma_4(\phi, \psi | r = \langle g^+, g^+, g^-, g^- \rangle)$ , 0.00%

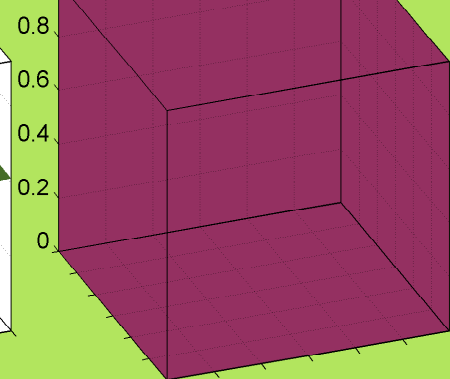

ARG:  $\gamma_4(\phi, \psi | r = \langle g^+, t, g^+, g^+ \rangle)$ , 0.55%

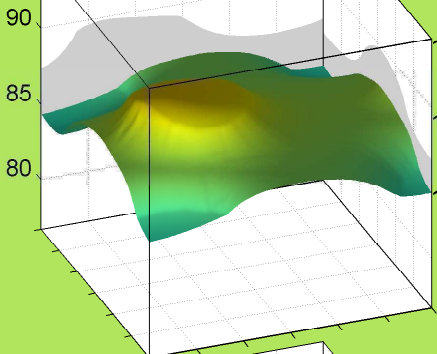

ARG:  $\gamma_4(\phi, \psi | r = \langle g^+, t, g^+, t \rangle)$ , 0.99%

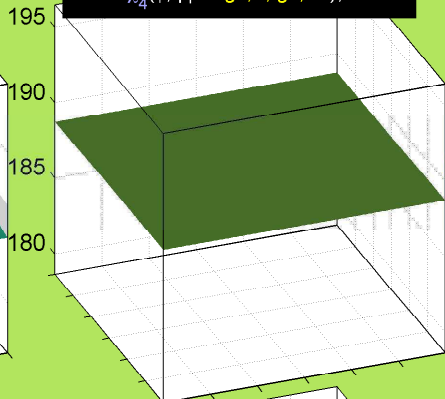

ARG:  $\gamma_4(\phi, \psi | r = \langle g^+, t, g^+, g^- \rangle)$ , 0.18%

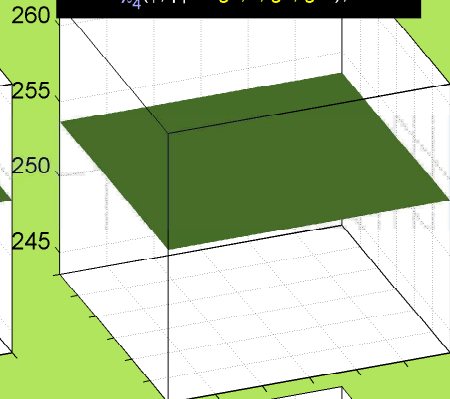

ARG:  $\gamma_4(\phi, \psi | r = \langle g^+, t, t, g^+ \rangle)$ , 1.68%

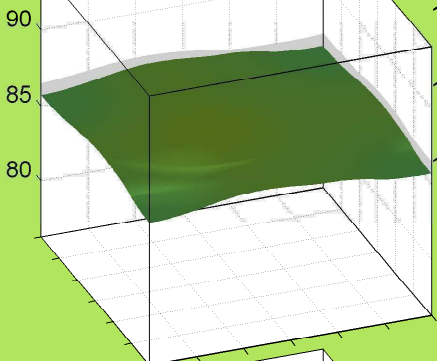

ARG:  $\gamma_4(\phi, \psi | r = \langle g^+, t, t, t \rangle)$ , 1.77%

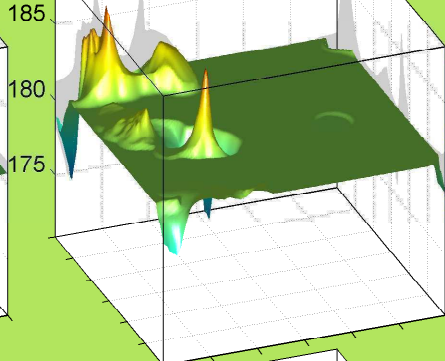

ARG:  $\gamma_4(\phi, \psi | r = \langle g^+, t, t, g^- \rangle)$ , 1.45%

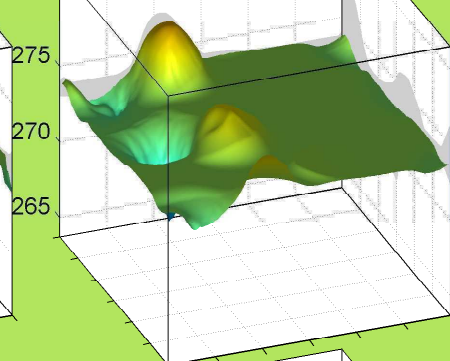

ARG:  $\gamma_4(\phi, \psi | r = \langle g^+, t, g^-, g^+ \rangle)$ , 0.09%

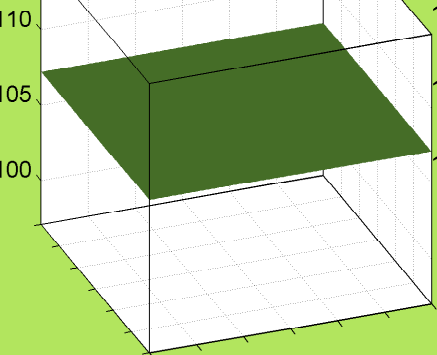

ARG:  $\gamma_4(\phi, \psi | r = \langle g^+, t, g^-, t \rangle)$ , 0.93%

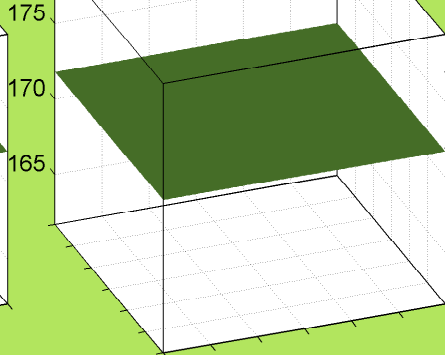

ARG:  $\gamma_4(\phi, \psi | r = \langle g^+, t, g^-, g^- \rangle)$ , 0.49%

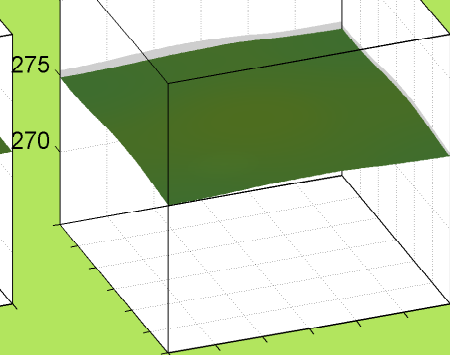

ARG:  $\chi_4(\phi, \psi|r=\langle g^+, g^-, g^+, g^+ \rangle)$ , 0.00%

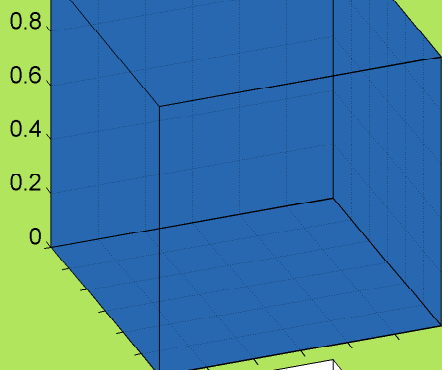

ARG:  $\chi_4(\phi, \psi|r=\langle g^+, g^-, g^+, t \rangle)$ , 0.00%

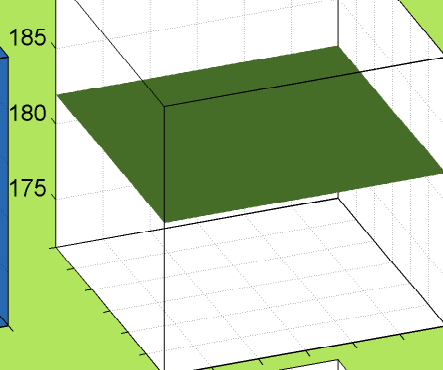

ARG:  $\chi_4(\phi, \psi|r=\langle g^+, g^-, g^+, g^- \rangle)$ , 0.00%

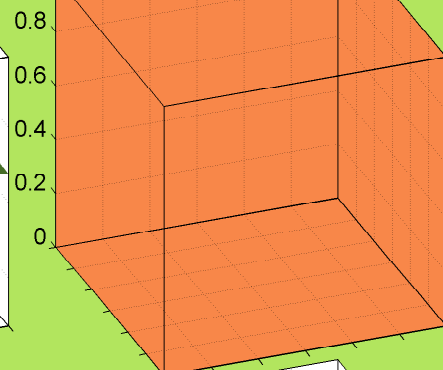

ARG:  $\chi_4(\phi, \psi|r=\langle g^+, g^-, t, g^+ \rangle)$ , 0.03%

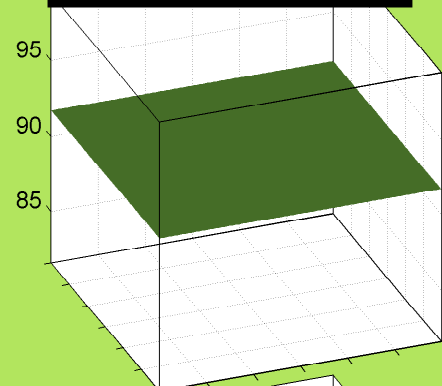

ARG:  $\chi_4(\phi, \psi|r=\langle g^+, g^-, t, t \rangle)$ , 0.07%

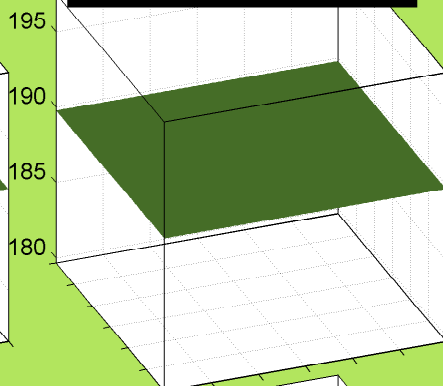

ARG:  $\chi_4(\phi, \psi|r=\langle g^+, g^-, t, g^- \rangle)$ , 0.06%

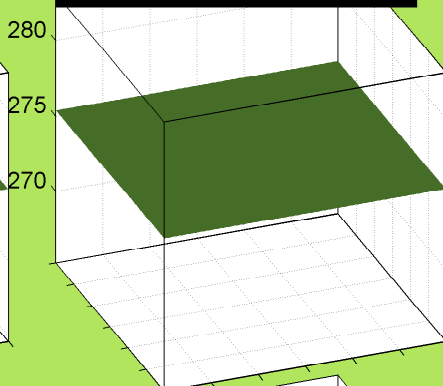

ARG:  $\chi_4(\phi, \psi|r=\langle g^+, g^-, g^-, g^+ \rangle)$ , 0.01%

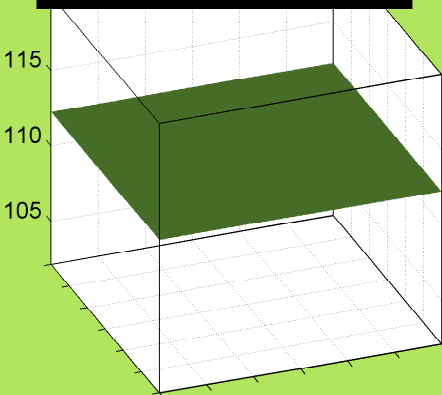

ARG:  $\chi_4(\phi, \psi|r=\langle g^+, g^-, g^-, t \rangle)$ , 0.05%

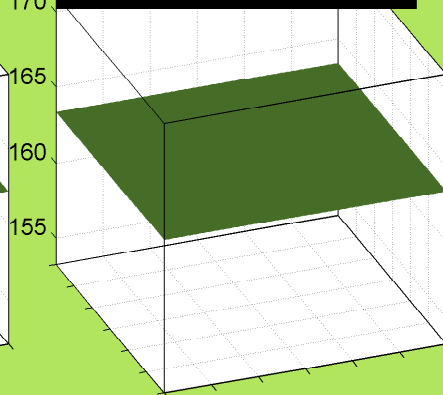

ARG:  $\chi_4(\phi, \psi|r=\langle g^+, g^-, g^-, g^- \rangle)$ , 0.05%

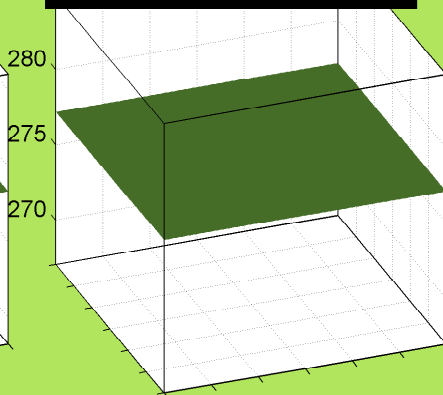

ARG:  $\gamma_4(\phi, \psi|r=\langle t, g^+, g^+, g^+ \rangle)$ , 0.76%

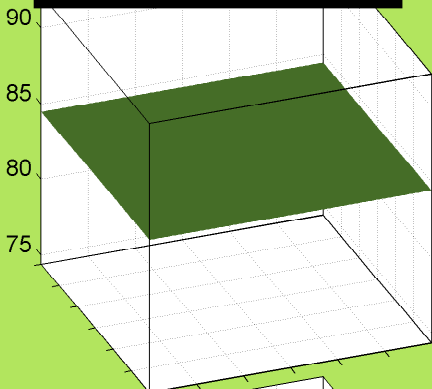

ARG:  $\gamma_4(\phi, \psi|r=\langle t, g^+, g^+, t \rangle)$ , 1.05%

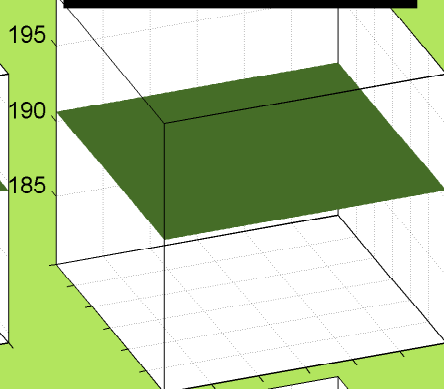

ARG:  $\gamma_4(\phi, \psi|r=\langle t, g^+, g^+, g^- \rangle)$ , 0.07%

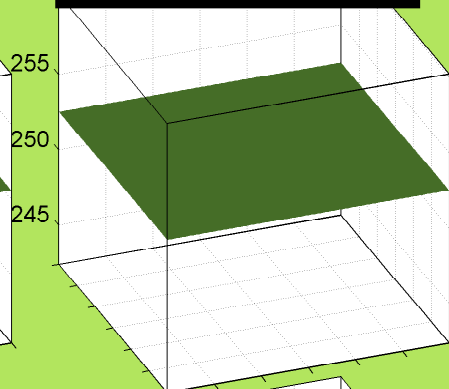

ARG:  $\gamma_4(\phi, \psi|r=\langle t, g^+, t, g^+ \rangle)$ , 1.23%

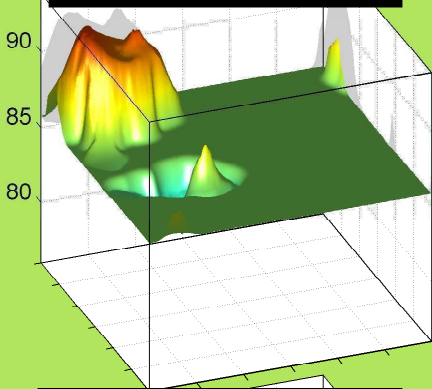

ARG:  $\gamma_4(\phi, \psi|r=\langle t, g^+, t, t \rangle)$ , 1.76%

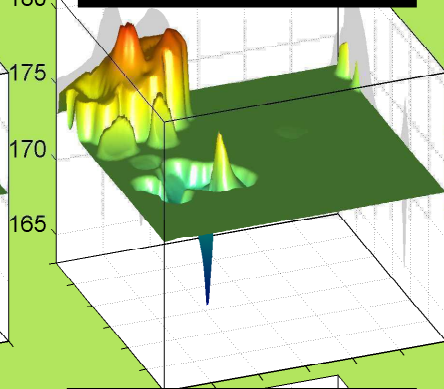

ARG:  $\gamma_4(\phi, \psi|r=\langle t, g^+, t, g^- \rangle)$ , 0.75%

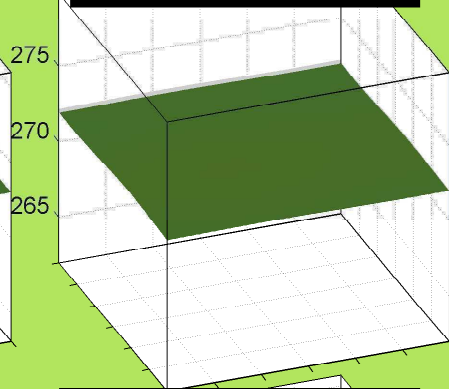

ARG:  $\gamma_4(\phi, \psi|r=\langle t, g^+, g^-, g^+ \rangle)$ , 0.01%

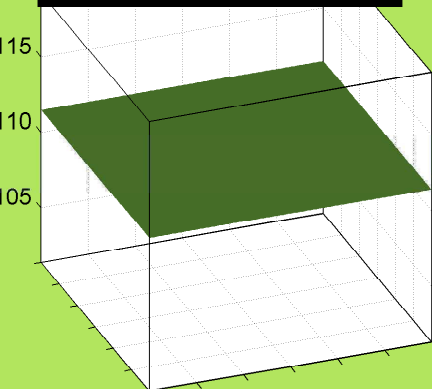

ARG:  $\gamma_4(\phi, \psi|r=\langle t, g^+, g^-, t \rangle)$ , 0.23%

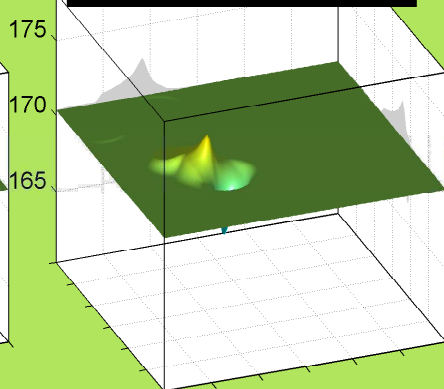

ARG:  $\gamma_4(\phi, \psi|r=\langle t, g^+, g^-, g^- \rangle)$ , 0.07%

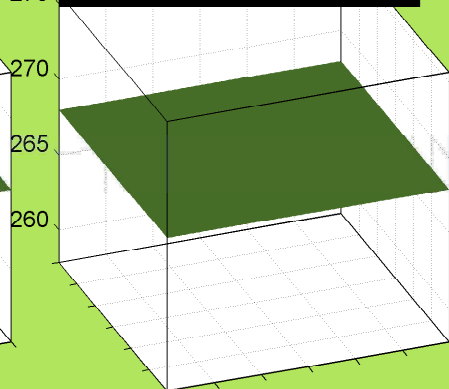

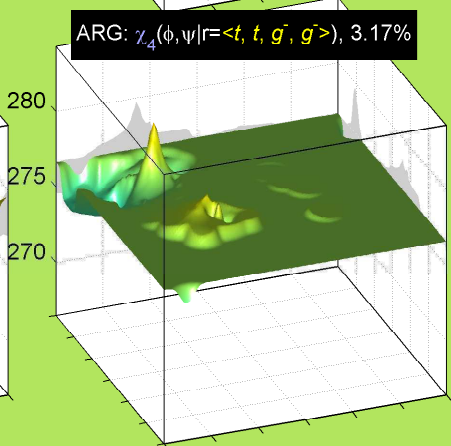
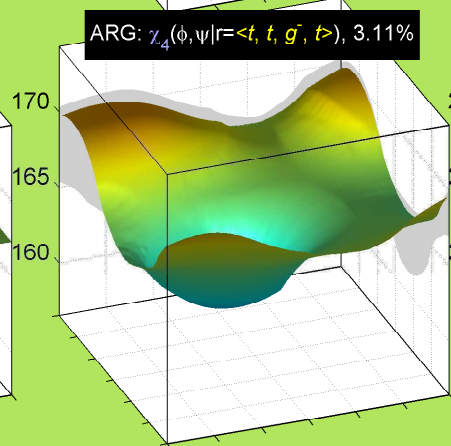
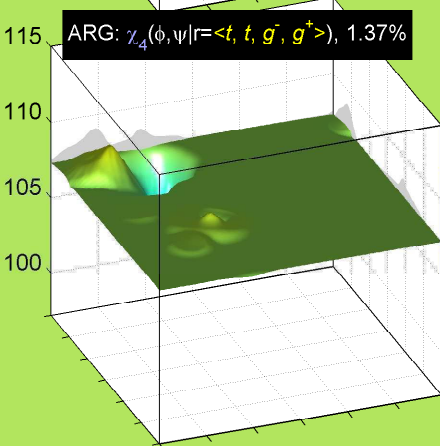
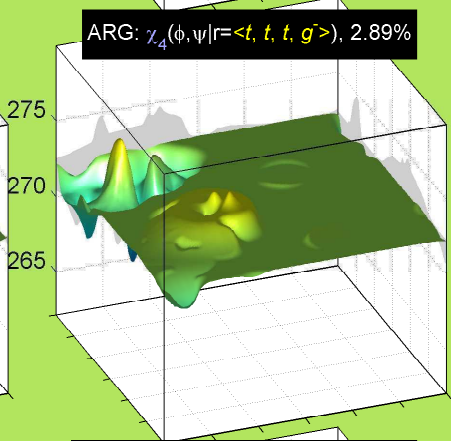
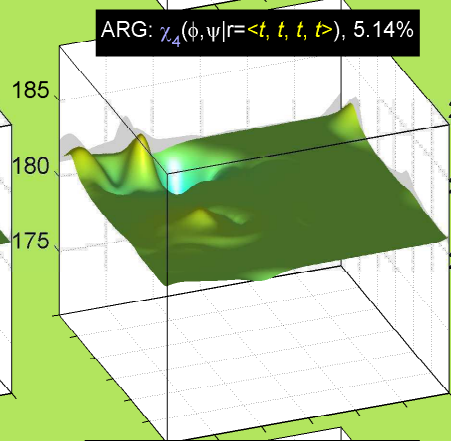
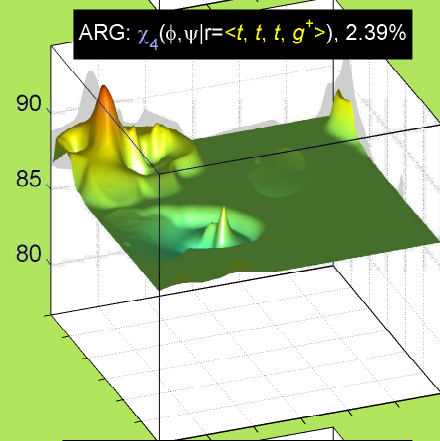
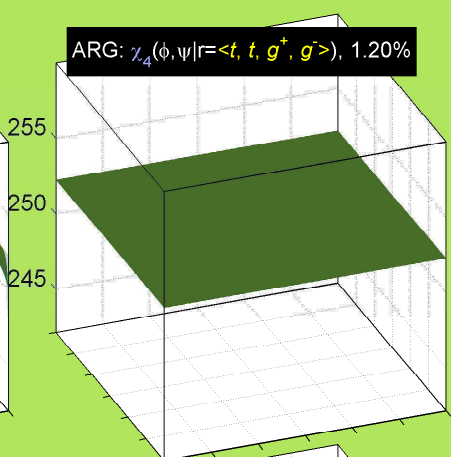
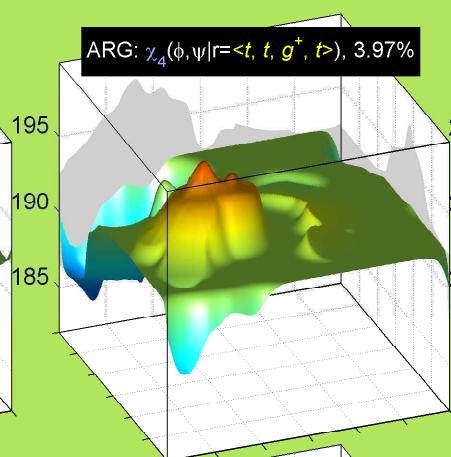
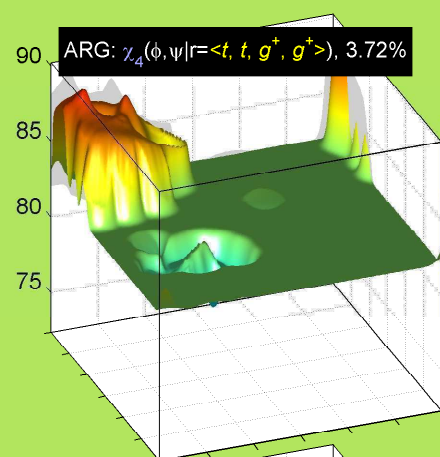

ARG:  $\chi_4(\phi, \psi | r = \langle t, g^-, g^+, g^+ \rangle)$ , 0.00%

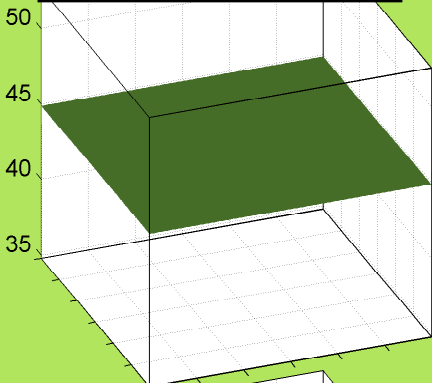

ARG:  $\chi_4(\phi, \psi | r = \langle t, g^-, g^+, t \rangle)$ , 0.01%

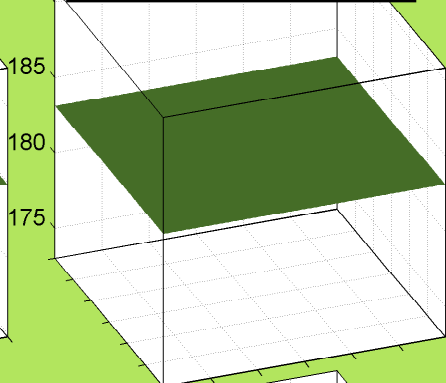

ARG:  $\chi_4(\phi, \psi | r = \langle t, g^-, g^+, g^- \rangle)$ , 0.00%

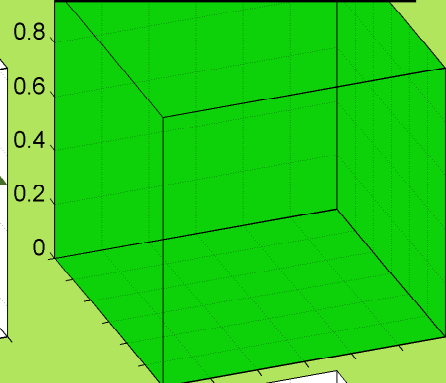

ARG:  $\chi_4(\phi, \psi | r = \langle t, g^-, t, g^+ \rangle)$ , 0.07%

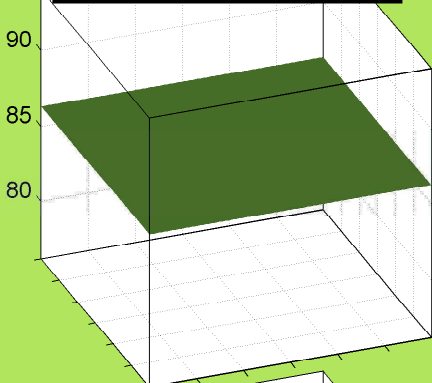

ARG:  $\chi_4(\phi, \psi | r = \langle t, g^-, t, t \rangle)$ , 0.28%

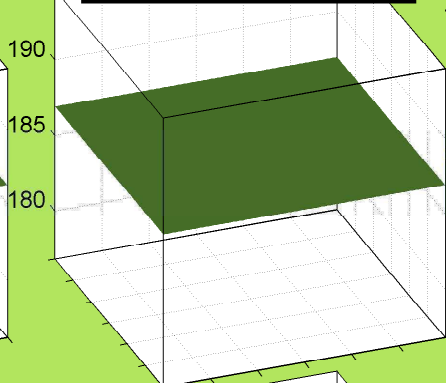

ARG:  $\chi_4(\phi, \psi | r = \langle t, g^-, t, g^- \rangle)$ , 0.15%

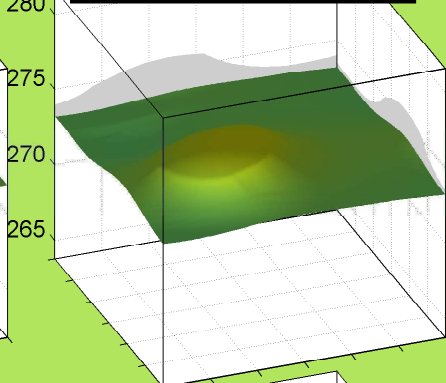

ARG:  $\chi_4(\phi, \psi | r = \langle t, g^-, g^-, g^+ \rangle)$ , 0.02%

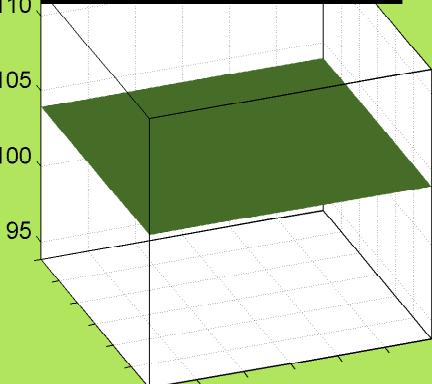

ARG:  $\chi_4(\phi, \psi | r = \langle t, g^-, g^-, t \rangle)$ , 0.22%

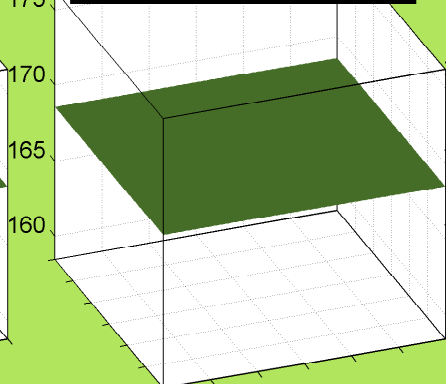

ARG:  $\chi_4(\phi, \psi | r = \langle t, g^-, g^-, g^- \rangle)$ , 0.17%

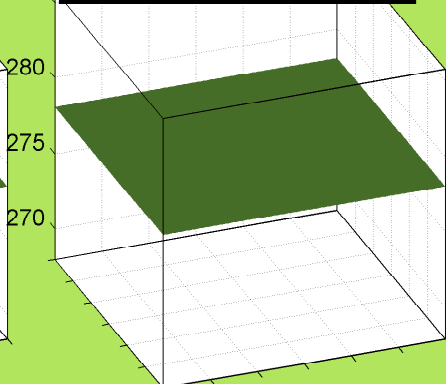

ARG:  $\chi_4(\phi, \psi|r=\langle g^-, g^+, g^+, g^+ \rangle)$ , 0.11%

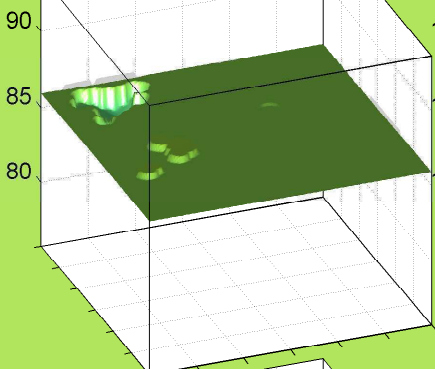

ARG:  $\chi_4(\phi, \psi|r=\langle g^-, g^+, g^+, t \rangle)$ , 0.17%

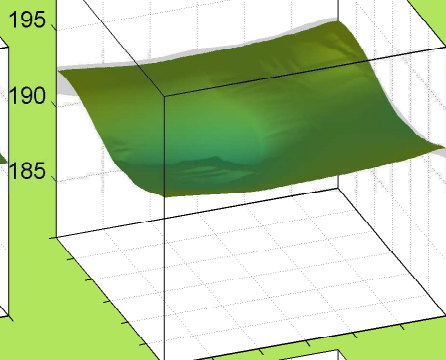

ARG:  $\chi_4(\phi, \psi|r=\langle g^-, g^+, g^+, g^- \rangle)$ , 0.00%

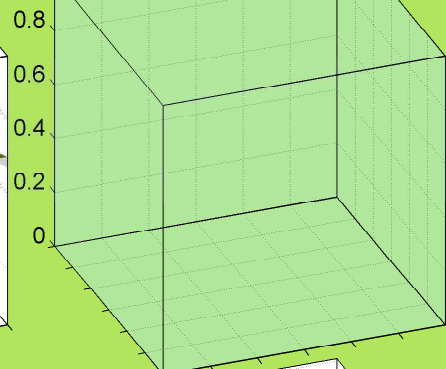

ARG:  $\chi_4(\phi, \psi|r=\langle g^-, g^+, t, g^+ \rangle)$ , 0.12%

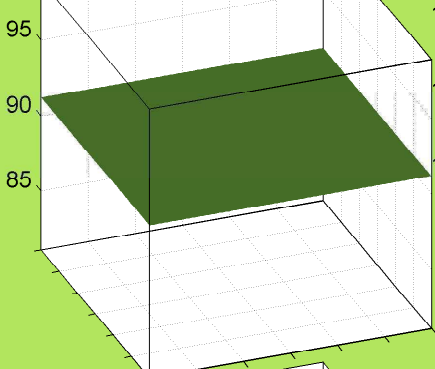

ARG:  $\chi_4(\phi, \psi|r=\langle g^-, g^+, t, t \rangle)$ , 0.60%

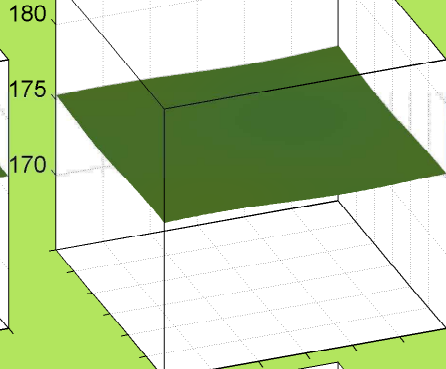

ARG:  $\chi_4(\phi, \psi|r=\langle g^-, g^+, t, g^- \rangle)$ , 0.15%

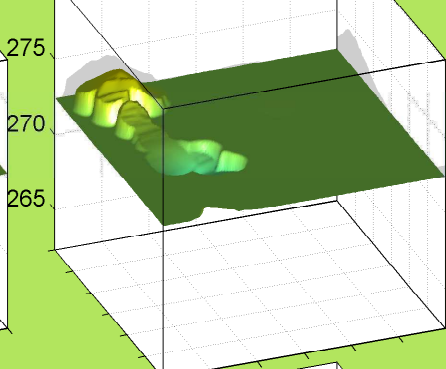

ARG:  $\chi_4(\phi, \psi|r=\langle g^-, g^+, g^-, g^+ \rangle)$ , 0.00%

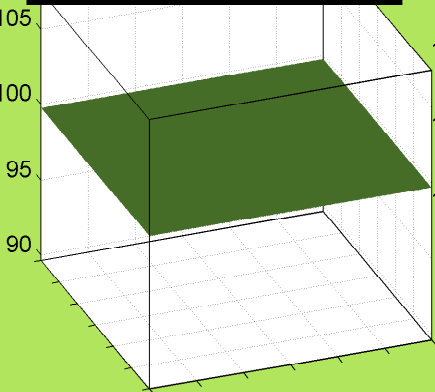

ARG:  $\chi_4(\phi, \psi|r=\langle g^-, g^+, g^-, t \rangle)$ , 0.02%

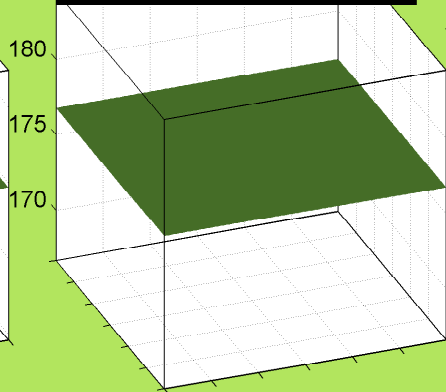

ARG:  $\chi_4(\phi, \psi|r=\langle g^-, g^+, g^-, g^- \rangle)$ , 0.03%

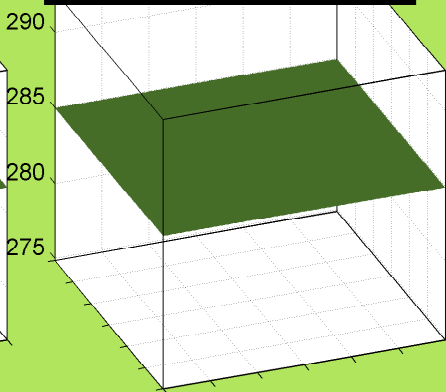

ARG:  $\chi_4(\phi, \psi | r = \langle g^-, t, g^+, g^+ \rangle)$ , 3.90%

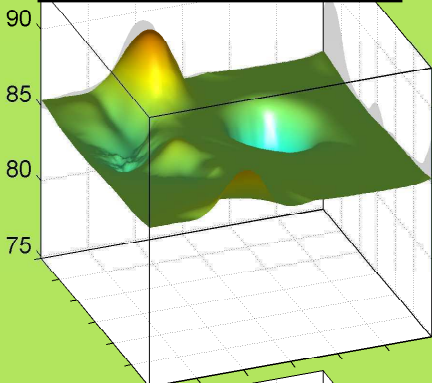

ARG:  $\chi_4(\phi, \psi | r = \langle g^-, t, g^+, t \rangle)$ , 5.87%

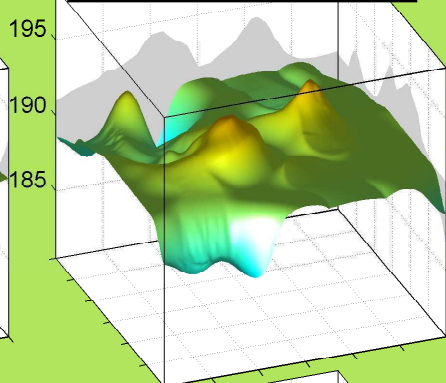

ARG:  $\chi_4(\phi, \psi | r = \langle g^-, t, g^+, g^- \rangle)$ , 0.87%

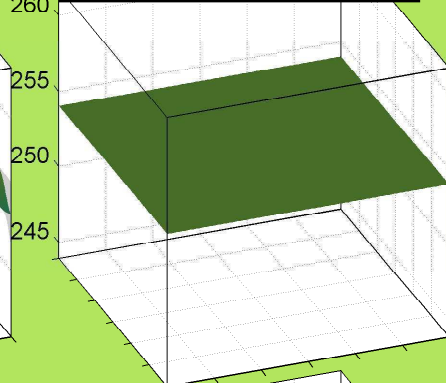

ARG:  $\chi_4(\phi, \psi | r = \langle g^-, t, t, g^+ \rangle)$ , 5.08%

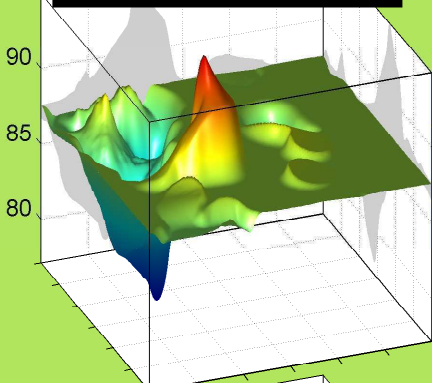

ARG:  $\chi_4(\phi, \psi | r = \langle g^-, t, t, t \rangle)$ , 10.04%

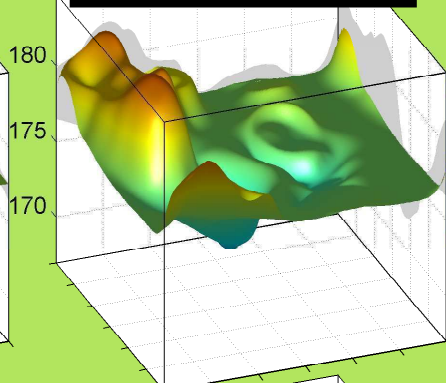

ARG:  $\chi_4(\phi, \psi | r = \langle g^-, t, t, g^- \rangle)$ , 5.95%

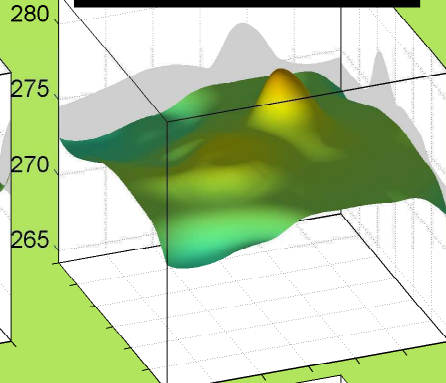

ARG:  $\chi_4(\phi, \psi | r = \langle g^-, t, g^-, g^+ \rangle)$ , 1.30%

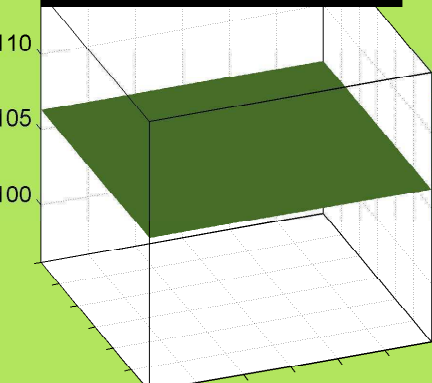

ARG:  $\chi_4(\phi, \psi | r = \langle g^-, t, g^-, t \rangle)$ , 5.86%

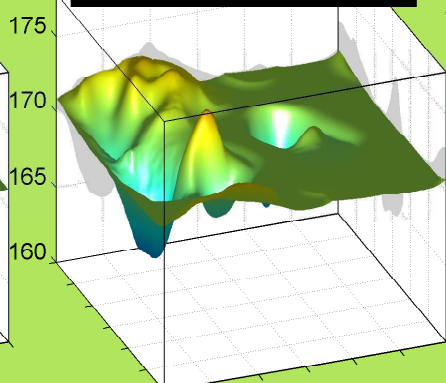

ARG:  $\chi_4(\phi, \psi | r = \langle g^-, t, g^-, g^- \rangle)$ , 5.55%

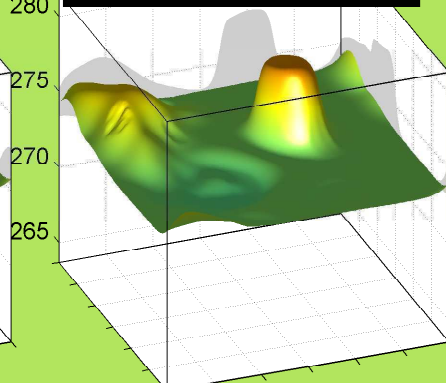



ARG:  $\chi_4(\phi, \psi | r = \langle g^-, g^-, g^+, g^+ \rangle)$ , 0.42%

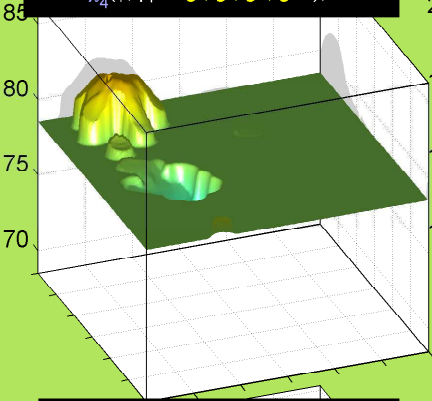

ARG:  $\chi_4(\phi, \psi | r = \langle g^-, g^-, g^+, t \rangle)$ , 0.36%

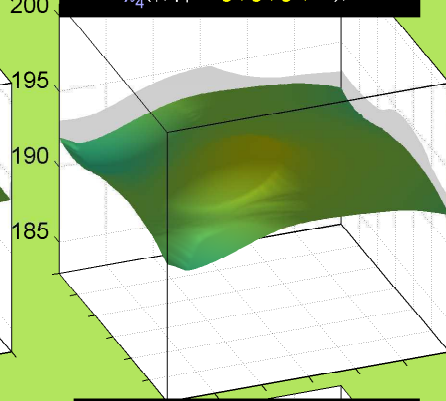

ARG:  $\chi_4(\phi, \psi | r = \langle g^-, g^-, g^+, g^- \rangle)$ , 0.03%

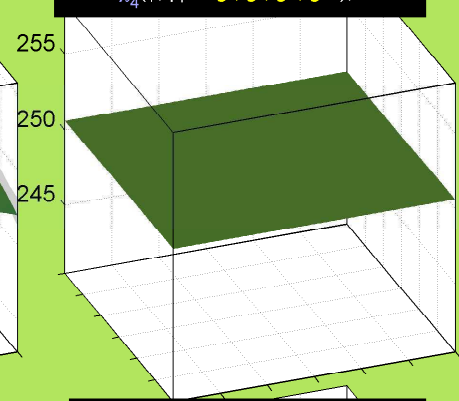

ARG:  $\chi_4(\phi, \psi | r = \langle g^-, g^-, t, g^+ \rangle)$ , 1.29%

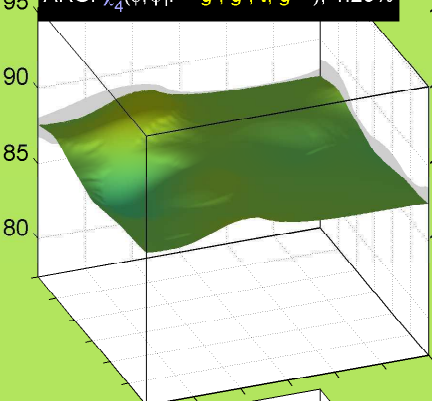

ARG:  $\chi_4(\phi, \psi | r = \langle g^-, g^-, t, t \rangle)$ , 2.76%

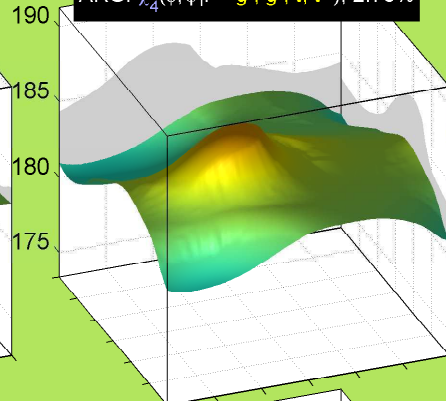

ARG:  $\chi_4(\phi, \psi | r = \langle g^-, g^-, t, g^- \rangle)$ , 2.75%

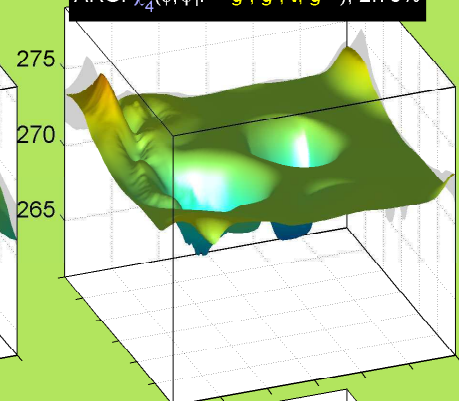

ARG:  $\chi_4(\phi, \psi | r = \langle g^-, g^-, g^-, g^+ \rangle)$ , 0.18%

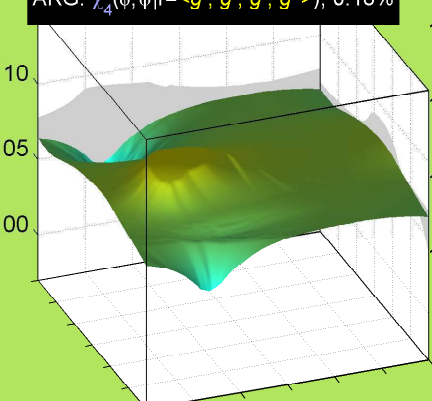

ARG:  $\chi_4(\phi, \psi | r = \langle g^-, g^-, g^-, t \rangle)$ , 1.88%

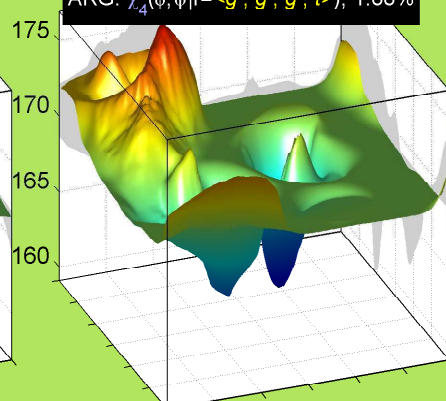

ARG:  $\chi_4(\phi, \psi | r = \langle g^-, g^-, g^-, g^- \rangle)$ , 2.18%

