

ARG: $\gamma_3(\phi, \psi | r = \langle g^+, t, g^+, g^+ \rangle)$, 0.55%

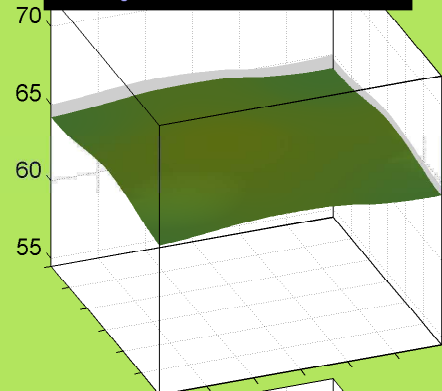

ARG: $\gamma_3(\phi, \psi | r = \langle g^+, t, g^+, t \rangle)$, 0.99%

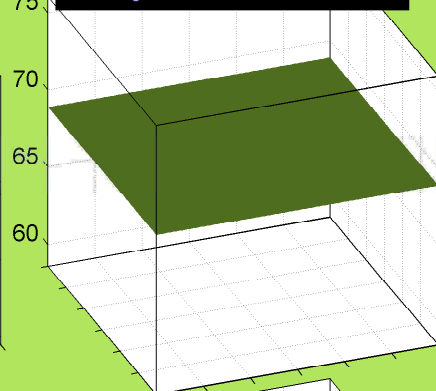

ARG: $\gamma_3(\phi, \psi | r = \langle g^+, t, g^+, g^- \rangle)$, 0.18%

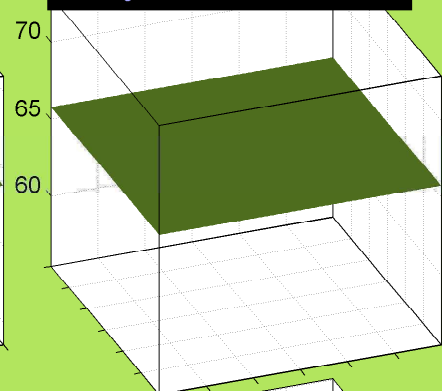

ARG: $\gamma_3(\phi, \psi | r = \langle g^+, t, t, g^+ \rangle)$, 1.68%

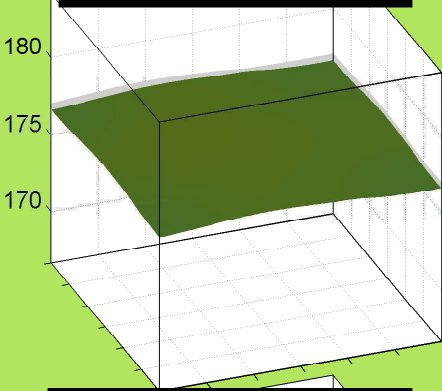

ARG: $\gamma_3(\phi, \psi | r = \langle g^+, t, t, t \rangle)$, 1.77%

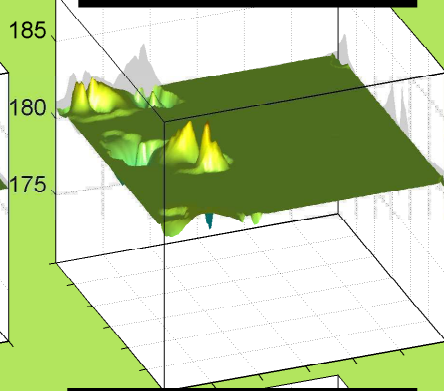

ARG: $\gamma_3(\phi, \psi | r = \langle g^+, t, t, g^- \rangle)$, 1.45%

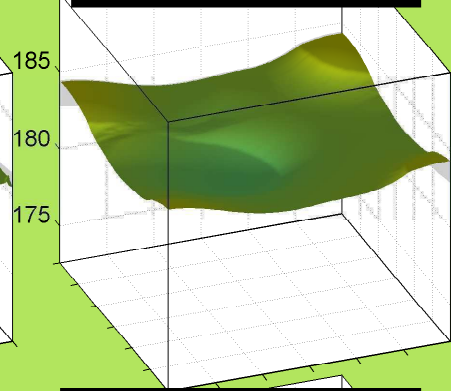

ARG: $\gamma_3(\phi, \psi | r = \langle g^+, t, g^-, g^+ \rangle)$, 0.09%

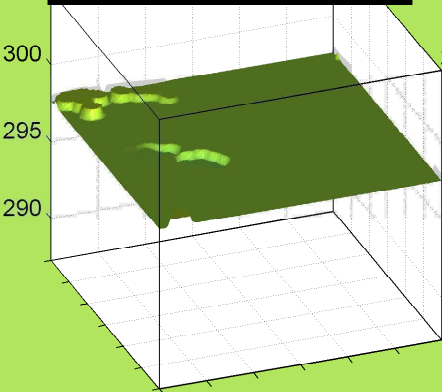

ARG: $\gamma_3(\phi, \psi | r = \langle g^+, t, g^-, t \rangle)$, 0.93%

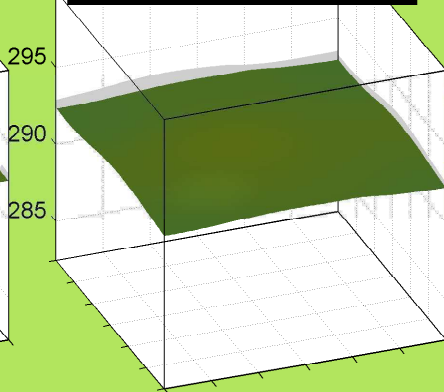

ARG: $\gamma_3(\phi, \psi | r = \langle g^+, t, g^-, g^- \rangle)$, 0.49%

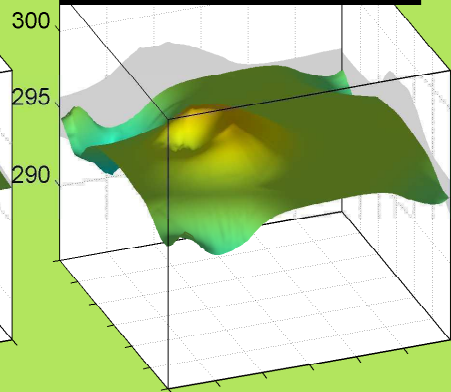

ARG: $\chi_3(\phi, \psi | r = \langle g^+, g^-, g^+, g^+ \rangle)$, 0.00%

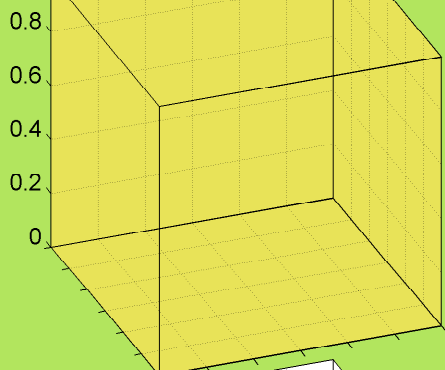

ARG: $\chi_3(\phi, \psi | r = \langle g^+, g^-, g^+, t \rangle)$, 0.00%

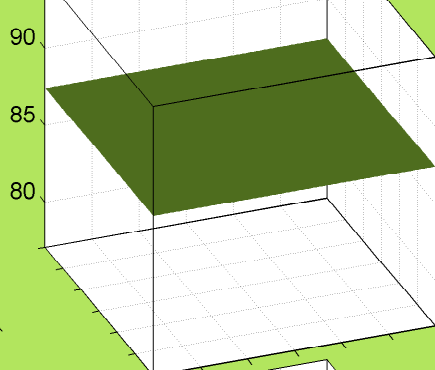

ARG: $\chi_3(\phi, \psi | r = \langle g^+, g^-, g^+, g^- \rangle)$, 0.00%

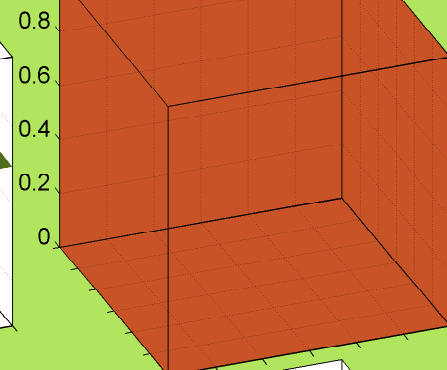

ARG: $\chi_3(\phi, \psi | r = \langle g^+, g^-, t, g^+ \rangle)$, 0.03%

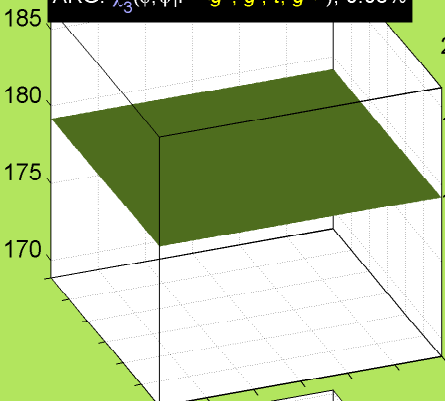

ARG: $\chi_3(\phi, \psi | r = \langle g^+, g^-, t, t \rangle)$, 0.07%

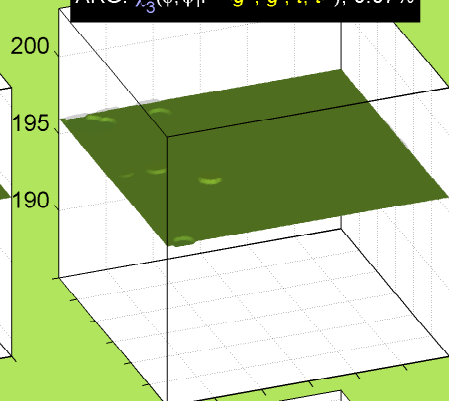

ARG: $\chi_3(\phi, \psi | r = \langle g^+, g^-, t, g^- \rangle)$, 0.06%

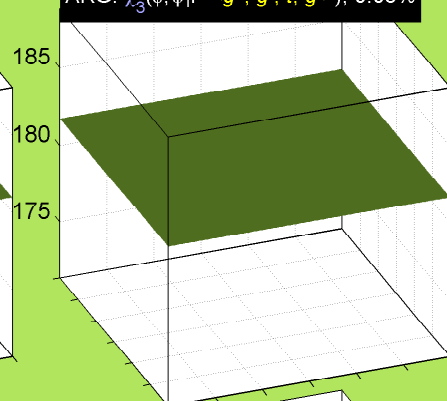

ARG: $\chi_3(\phi, \psi | r = \langle g^+, g^-, g^-, g^+ \rangle)$, 0.01%

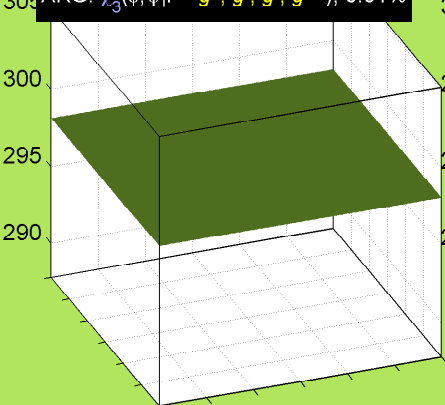

ARG: $\chi_3(\phi, \psi | r = \langle g^+, g^-, g^-, t \rangle)$, 0.05%

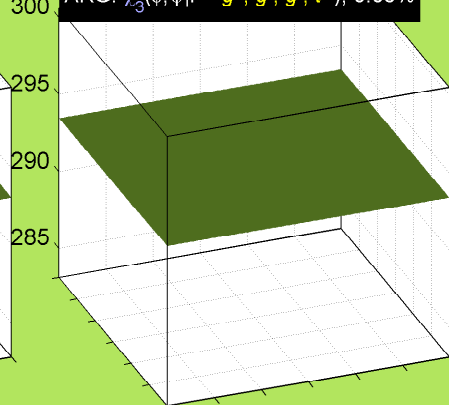

ARG: $\chi_3(\phi, \psi | r = \langle g^+, g^-, g^-, g^- \rangle)$, 0.05%

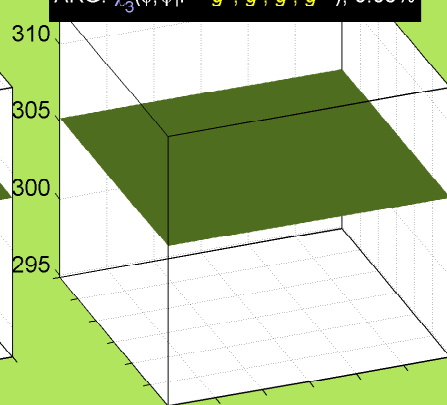

ARG: $\gamma_3(\phi, \psi | r = \langle t, g^+, g^+, g^+ \rangle)$, 0.76%

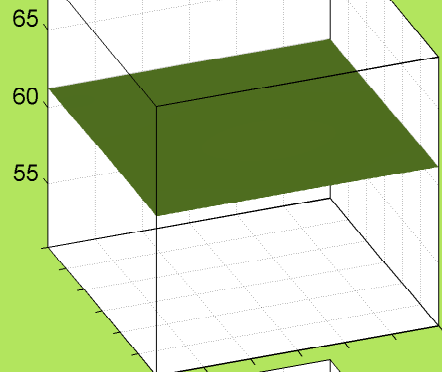

ARG: $\gamma_3(\phi, \psi | r = \langle t, g^+, g^+, t \rangle)$, 1.05%

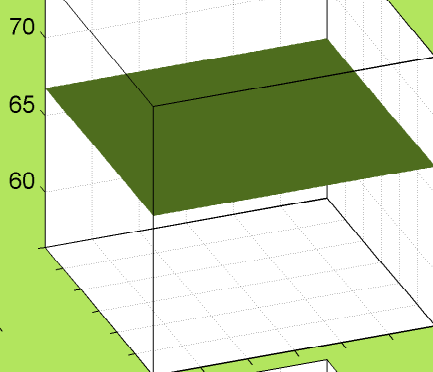

ARG: $\gamma_3(\phi, \psi | r = \langle t, g^+, g^+, g^- \rangle)$, 0.07%

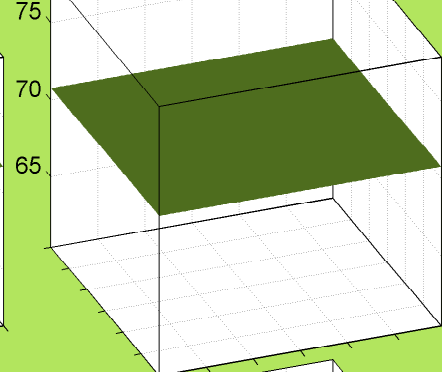

ARG: $\gamma_3(\phi, \psi | r = \langle t, g^+, t, g^+ \rangle)$, 1.23%

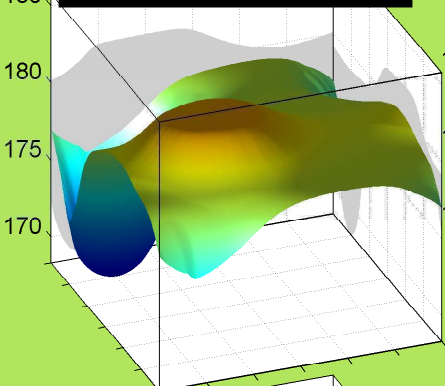

ARG: $\gamma_3(\phi, \psi | r = \langle t, g^+, t, t \rangle)$, 1.76%

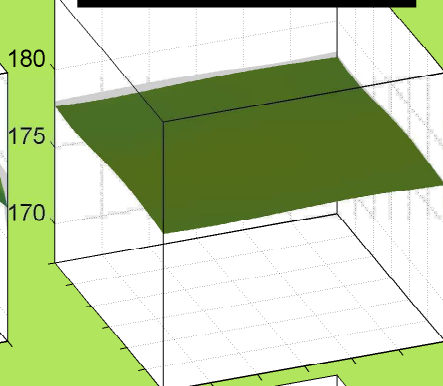

ARG: $\gamma_3(\phi, \psi | r = \langle t, g^+, t, g^- \rangle)$, 0.75%

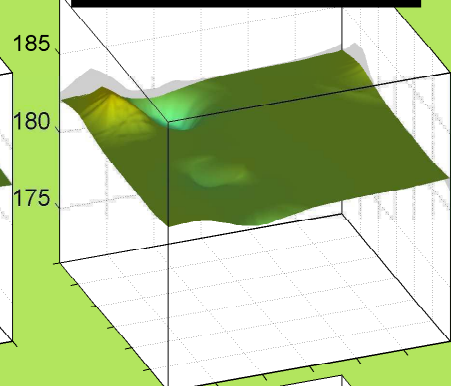

ARG: $\gamma_3(\phi, \psi | r = \langle t, g^+, g^-, g^+ \rangle)$, 0.01%

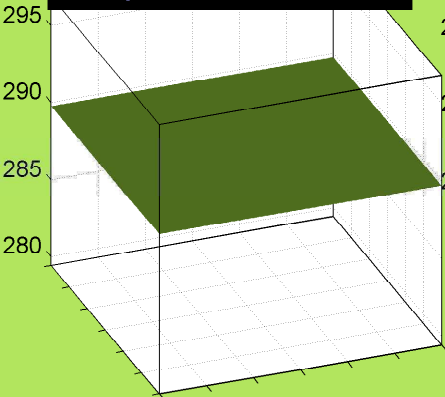

ARG: $\gamma_3(\phi, \psi | r = \langle t, g^+, g^-, t \rangle)$, 0.23%

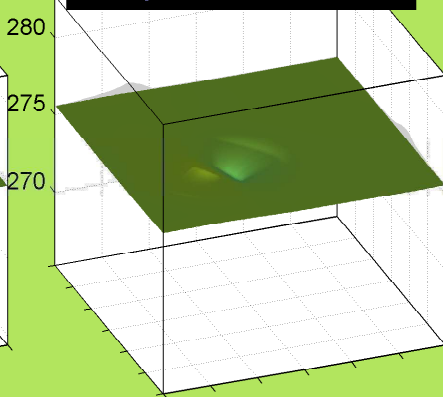

ARG: $\gamma_3(\phi, \psi | r = \langle t, g^+, g^-, g^- \rangle)$, 0.07%

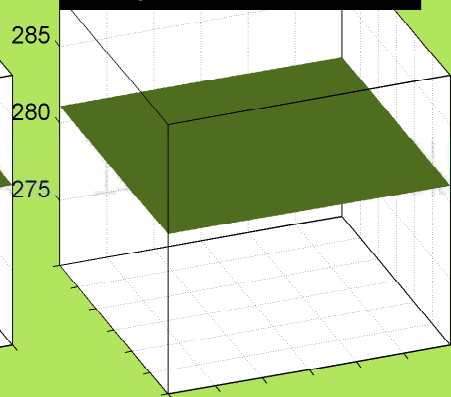

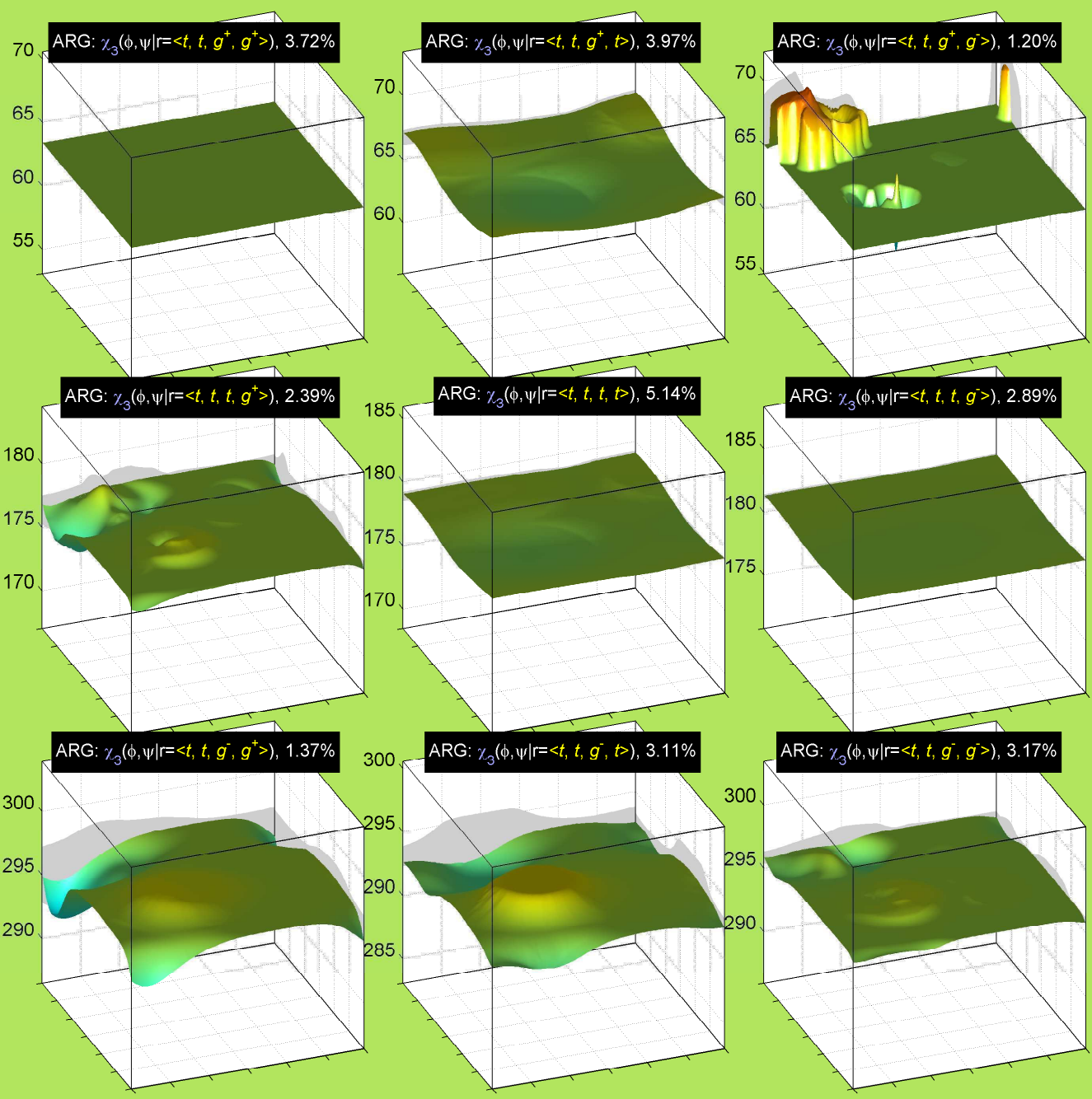

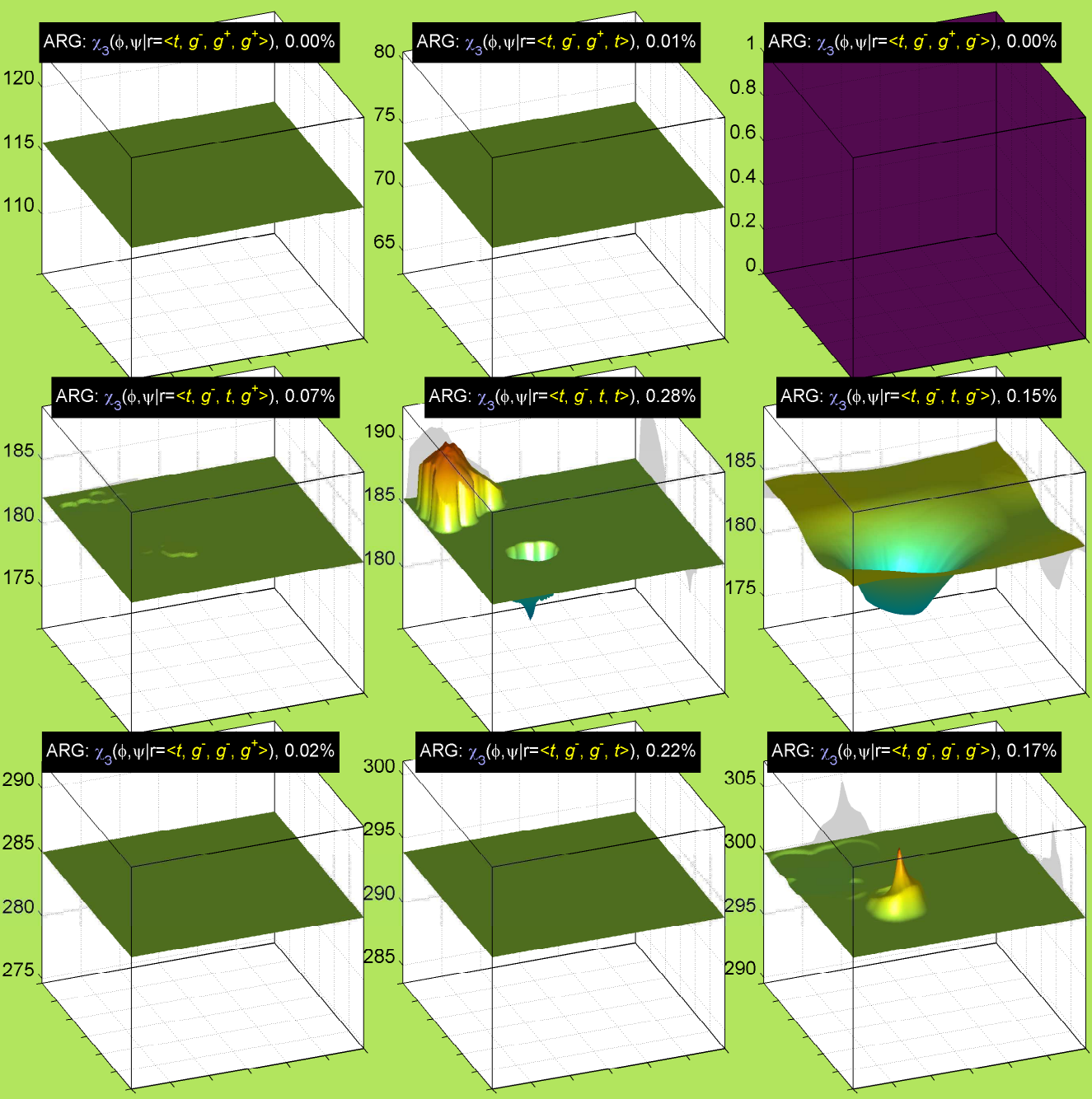

ARG: $\chi_3(\phi, \psi | r = \langle g^-, g^+, g^+, g^+ \rangle)$, 0.11%

ARG: $\chi_3(\phi, \psi | r = \langle g^-, g^+, g^+, t \rangle)$, 0.17%

ARG: $\chi_3(\phi, \psi | r = \langle g^-, g^+, g^+, g^- \rangle)$, 0.00%

ARG: $\chi_3(\phi, \psi | r = \langle g^-, g^+, t, g^+ \rangle)$, 0.12%

ARG: $\chi_3(\phi, \psi | r = \langle g^-, g^+, t, t \rangle)$, 0.60%

ARG: $\chi_3(\phi, \psi | r = \langle g^-, g^+, t, g^- \rangle)$, 0.15%

ARG: $\chi_3(\phi, \psi | r = \langle g^-, g^+, g^-, g^+ \rangle)$, 0.00%

ARG: $\chi_3(\phi, \psi | r = \langle g^-, g^+, g^-, t \rangle)$, 0.02%

ARG: $\chi_3(\phi, \psi | r = \langle g^-, g^+, g^-, g^- \rangle)$, 0.03%

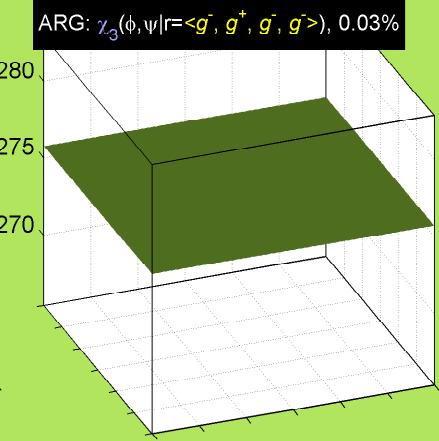
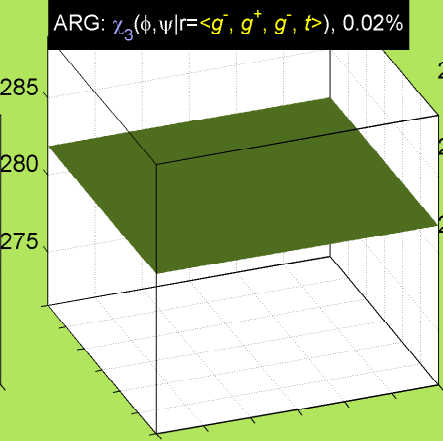
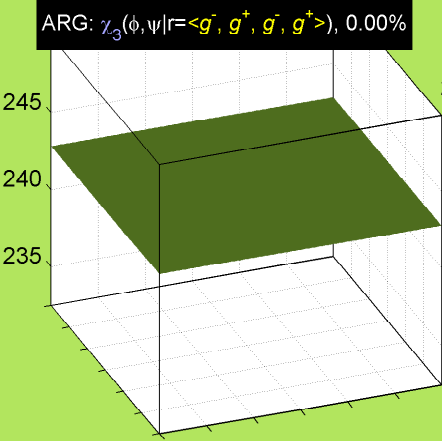
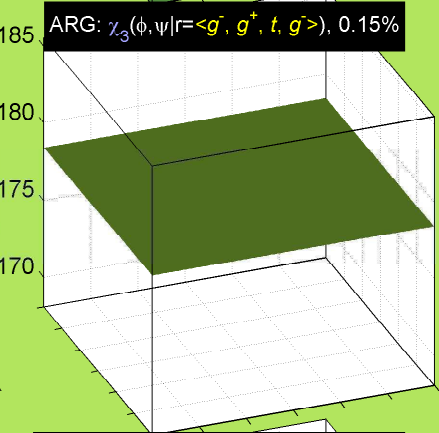
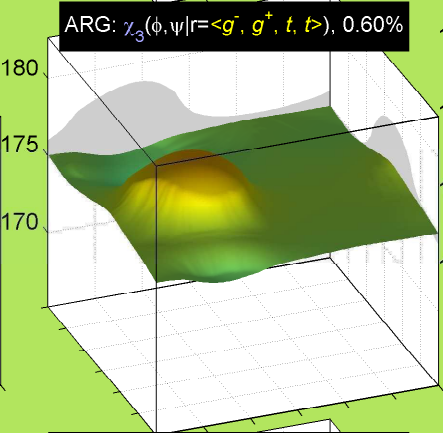
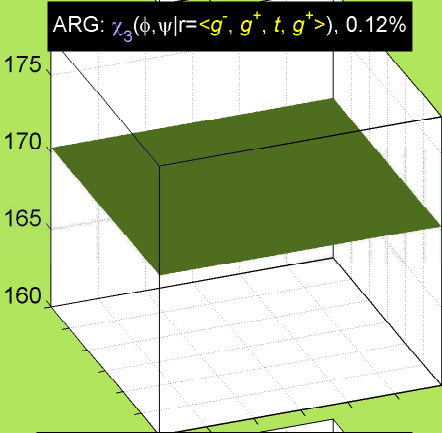
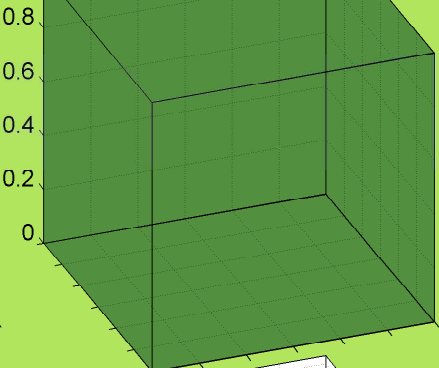
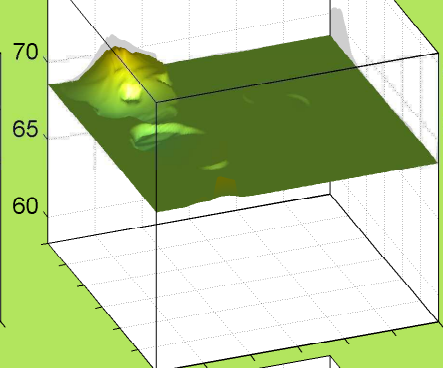
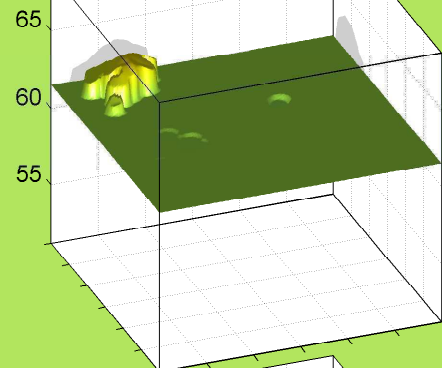

ARG: $\chi_3(\phi, \psi | r = \langle g^-, t, g^+, g^+ \rangle)$, 3.90%

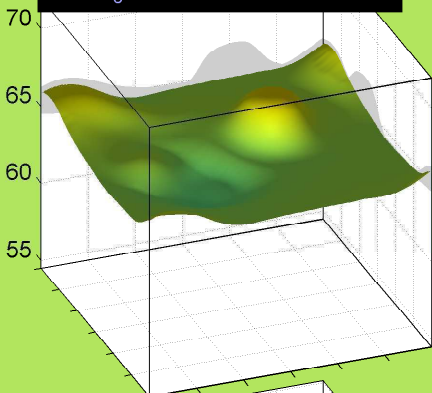

ARG: $\chi_3(\phi, \psi | r = \langle g^-, t, g^+, t \rangle)$, 5.87%

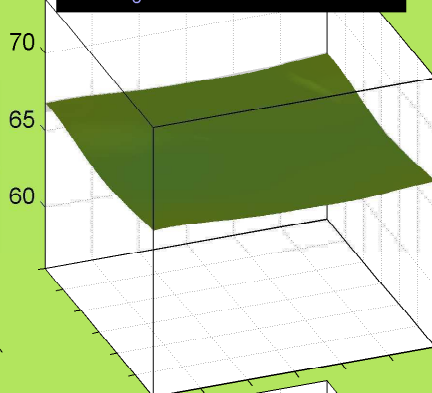

ARG: $\chi_3(\phi, \psi | r = \langle g^-, t, g^+, g^- \rangle)$, 0.87%

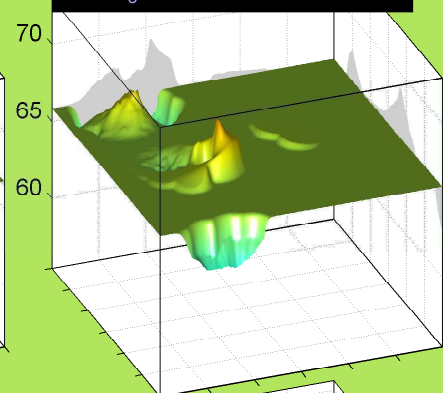

ARG: $\chi_3(\phi, \psi | r = \langle g^-, t, t, g^+ \rangle)$, 5.08%

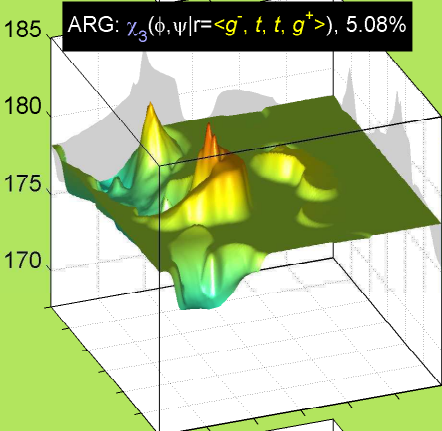

ARG: $\chi_3(\phi, \psi | r = \langle g^-, t, t, t \rangle)$, 10.04%

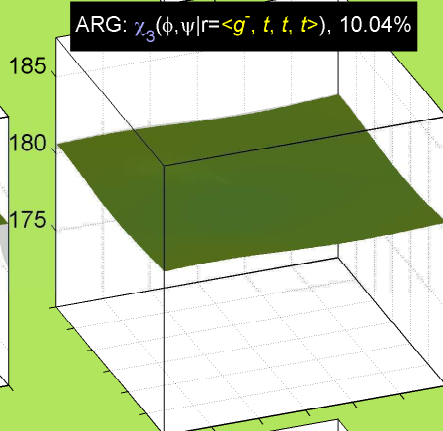

ARG: $\chi_3(\phi, \psi | r = \langle g^-, t, t, g^- \rangle)$, 5.95%

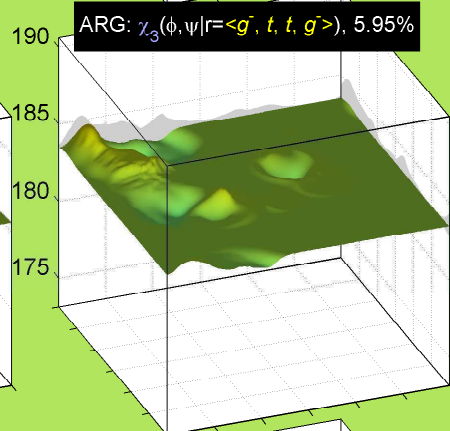

ARG: $\chi_3(\phi, \psi | r = \langle g^-, t, g^-, g^+ \rangle)$, 1.30%

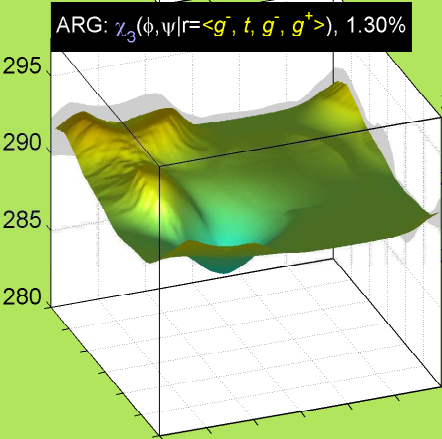

ARG: $\chi_3(\phi, \psi | r = \langle g^-, t, g^-, t \rangle)$, 5.86%

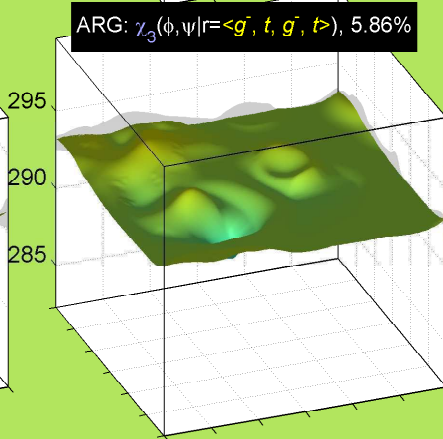

ARG: $\chi_3(\phi, \psi | r = \langle g^-, t, g^-, g^- \rangle)$, 5.55%

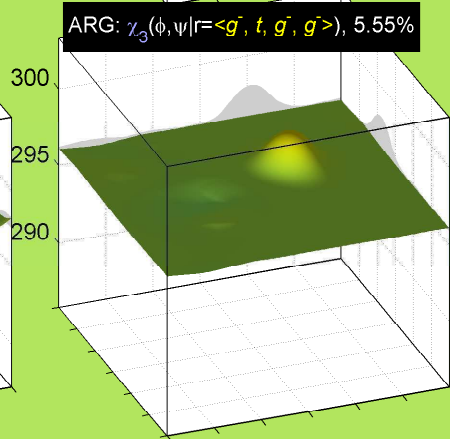

ARG: $\chi_3(\phi, \psi | r = \langle g^-, g^-, g^+, g^+ \rangle)$, 0.42%

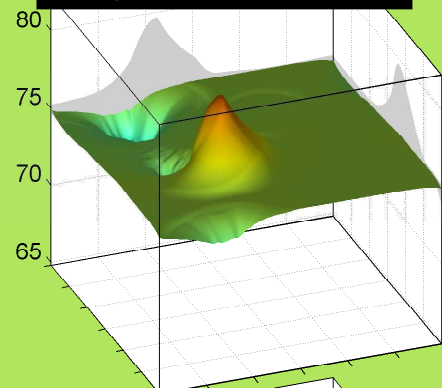

ARG: $\chi_3(\phi, \psi | r = \langle g^-, g^-, g^+, t \rangle)$, 0.36%

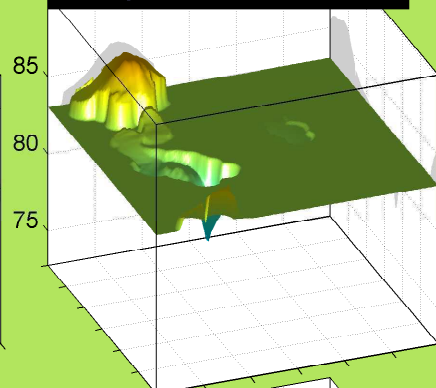

ARG: $\chi_3(\phi, \psi | r = \langle g^-, g^-, g^+, g^- \rangle)$, 0.03%

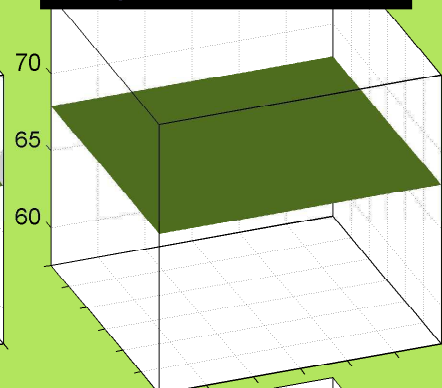

ARG: $\chi_3(\phi, \psi | r = \langle g^-, g^-, t, g^+ \rangle)$, 1.29%

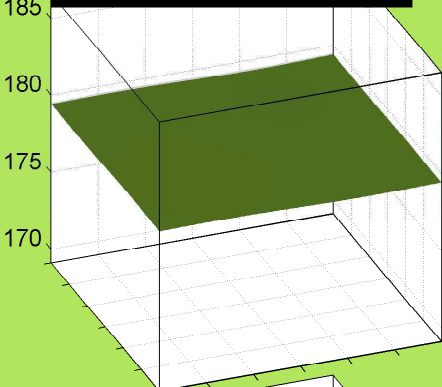

ARG: $\chi_3(\phi, \psi | r = \langle g^-, g^-, t, t \rangle)$, 2.76%

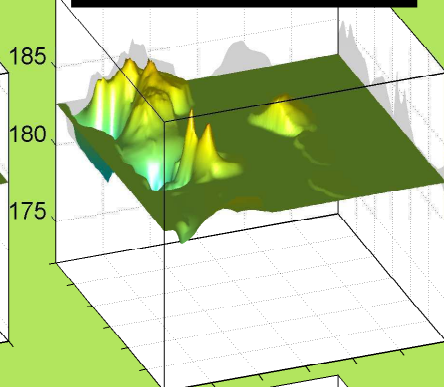

ARG: $\chi_3(\phi, \psi | r = \langle g^-, g^-, t, g^- \rangle)$, 2.75%

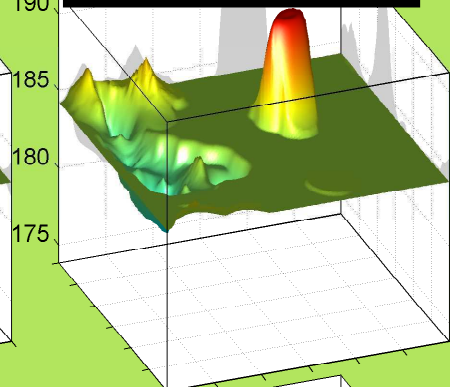

ARG: $\chi_3(\phi, \psi | r = \langle g^-, g^-, g^-, g^+ \rangle)$, 0.18%

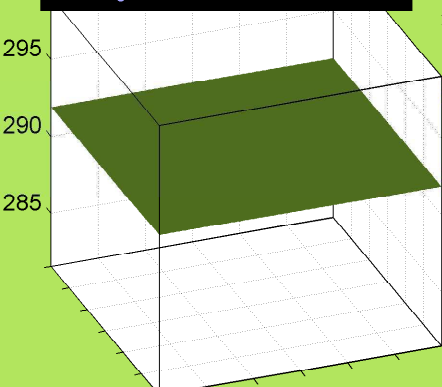

ARG: $\chi_3(\phi, \psi | r = \langle g^-, g^-, g^-, t \rangle)$, 1.88%

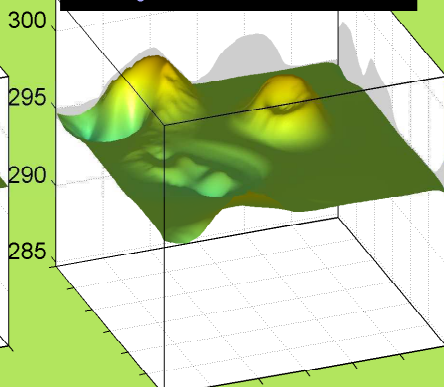

ARG: $\chi_3(\phi, \psi | r = \langle g^-, g^-, g^-, g^- \rangle)$, 2.18%

